

Atlas Copco

Atlas Copco

GA75VSD+

Atlas Copco

GA75VSD+

Oil-injected rotary screw compressors

GA 37-110 VSD+ (37-110 kW/50-150 hp)

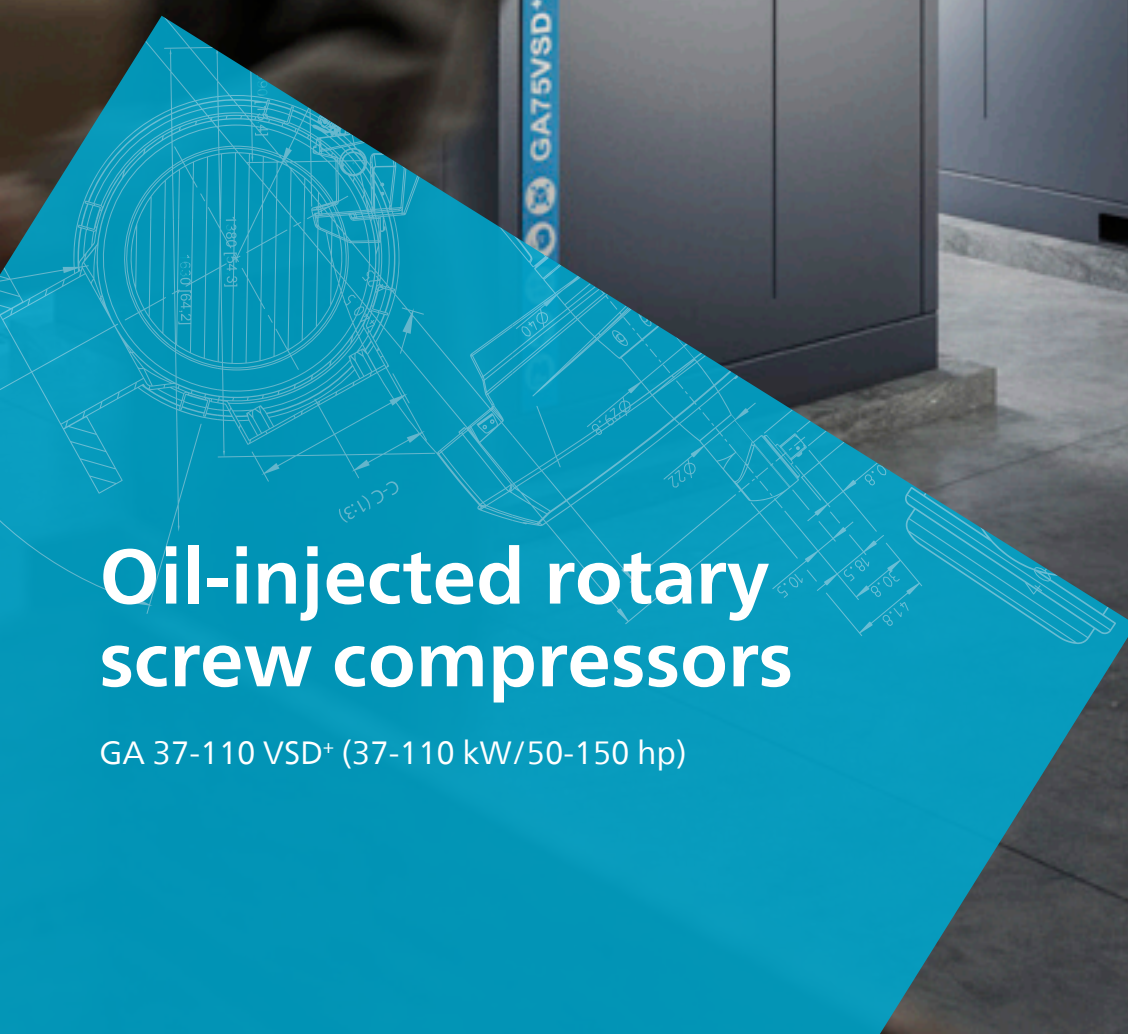



GA90VSD+

The new revolutionary compressor from Atlas Copco

Atlas Copco's GA 37-110 VSD+ is not just a ground-breaking new compressor range, it is an operational transformation. It reduces your energy costs by 50% on average and maximizes uptime, even in the harshest conditions. Driving this next-level performance: Atlas Copco's Variable Speed Drive, a powerful interior permanent magnet motor, and our in-house developed Neos inverter. Thanks to its compact vertical design, the GA 37-110 VSD+ fits in even the smallest compressor room. Including yours? Discover how the GA 37-110 VSD+ can transform your operational environment today.



Innovative

Atlas Copco has revolutionized compressor build and performance. Instead of the normal space-taking horizontal design, the new GA 37-110 VSD+ has an upright, compact layout. This saves valuable floor and work space, eases maintenance access, and reduces the total cost of ownership for all customers.

Efficient

- Reduced energy consumption by 50% on average compared to the current idling models.
- Free Air Delivery (FAD) increase of up to 12%.

IE5

Meeting and exceeding efficiency benchmarks:

- The iPM motor of the GA 37-110 VSD+ equals IE5 standards.
- The Neos inverter and iPM motor exceed IES2 (EN 50598) requirements for power drive efficiency.

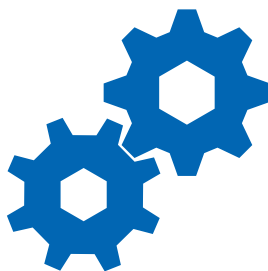

Reliable

- Our Neos inverter, developed in-house to maximize compressor reliability, is built to provide extra protection against dust and other particles.
- Completely enclosed frequency drive and drive train ensure performance even in the harshest environments.
- Based on the unique combination of proven technologies and existing components, optimally brought together by Atlas Copco's experience and know-how.

Smart

- Easy monitoring and maintenance thanks to the Elektronikon® Touch controller.
- Maintenance notifications and machine status are available via SMARTLINK e-mail or text messages.
- Customized reports on the energy performance of your machine, in compliance with ISO 50001.



Inside the robust GA 37L-75 VSD+



IE5

Meeting and exceeding efficiency benchmarks:

- The iPM motor of the GA 37L-75 VSD+ equals IE5 standards.
- Neos inverter and iPM motor exceed IES2 (EN 50598) requirements for power drive efficiency.

1

Interior Permanent Magnet (iPM) motor

- Oil-cooled motor.
- Optimal cooling for all speeds and ambient conditions.
- Designed in-house in Belgium.
- Oil-lubricated motor bearing: no (re)grease(ing), increased uptime.
- IP66: pressure tight.
- Permanent magnets.

2

New compressor element

- New improved rotor profile.
- Reduced pressure losses.
- Optimized in and outlet portals.

3

Direct drive

- Vertical design, less parts.
- Oil-cooled, pressure-tight.
- No gears or belts, no shaft seal.

4

Inlet filter

- Heavy duty.
- Maintenance every 4,000 hours.
- Pressure drop indicator.



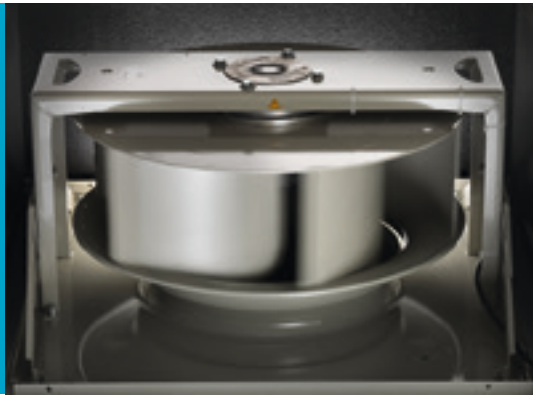

5

Radial fan

- Compact.
- Low noise level.
- High capacity for optimized cooling.

6

Classic cooler design

- Integrated water separation.
- Separate oil/air cooler.
- Easy access for maintenance.

7

Innovative Neos inverter

- Atlas Copco's in-house designed inverter now also controls iPM motors.
- IP5x protection.
- Robust aluminum enclosure for trouble-free operation in the harshest conditions.
- Fewer components: compact, simple and user-friendly.



8

Integrated dryer

- Extra compact footprint.
- Refrigerant R410A.

9

Elektronik® Touch controller

- High-tech controller with warning indications, compressor shut-down and maintenance scheduling.
- Easy to use and designed to perform in the toughest conditions.
- Standard SMARTLINK remote monitoring to maximize air system performance and energy savings.
- Optional multiple compressor control (2, 4 or 6 compressors).

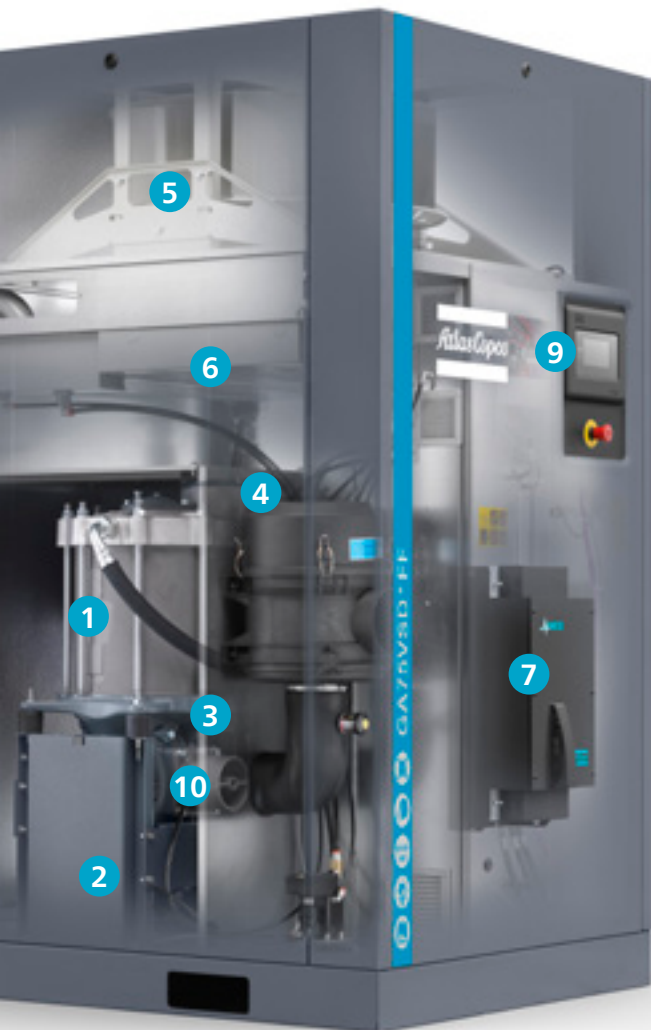

11

VSD+ Neos cubicle

- VSD+ is superior to idling machines.
- Electrical components remain cool, enhancing their lifetime.
- Dedicated drive for iPM technology motors.
- Heat dissipation of inverter in separate compartment.

10

Sentinel valve

- Optimizes the inlet flow of the air end.
- No blow-off losses.
- Full aluminum design: maintenance-free.

Inside the powerful GA 75L-110 VSD+

IE5

Meeting and exceeding efficiency benchmarks:

- The iPM motor of the GA 75L-110 VSD+ equals IE5 standards.
- Neos inverter and iPM motor exceed IES2 (EN 50598) requirements for power drive efficiency.

2

New compressor element

- Improved efficiency.
- Made by Atlas Copco.
- Robust and silent.

1

Interior Permanent Magnet (iPM) motor

- Compact, customized design for optimal cooling by oil.
- Designed in-house in Belgium.
- IP66 protection rating.
- No cooling air flow required.
- Oil-lubricated motor bearing: no (re)grease(ing) and increased uptime.

3

Direct drive

- Vertical design, less parts.
- Oil-cooled, pressure-tight.
- No gears or belts, no shaft seal.

4

Inlet filter

- Heavy duty.
- Pressure drop indicator.
- Maintenance every 4,000 hours.

5

Cooling fan

- Already compliant with future ERP2020 efficiency.
- Optimized, application-specific design results in low noise and high efficiency.
- Condensation prevention cycle based on inlet humidity sensor.

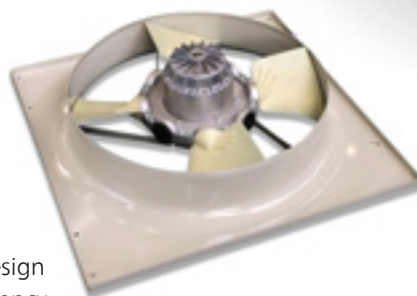

6

Classic cooler design

- Integrated water separation.
- Separate oil/air cooler.
- Easy access for maintenance.

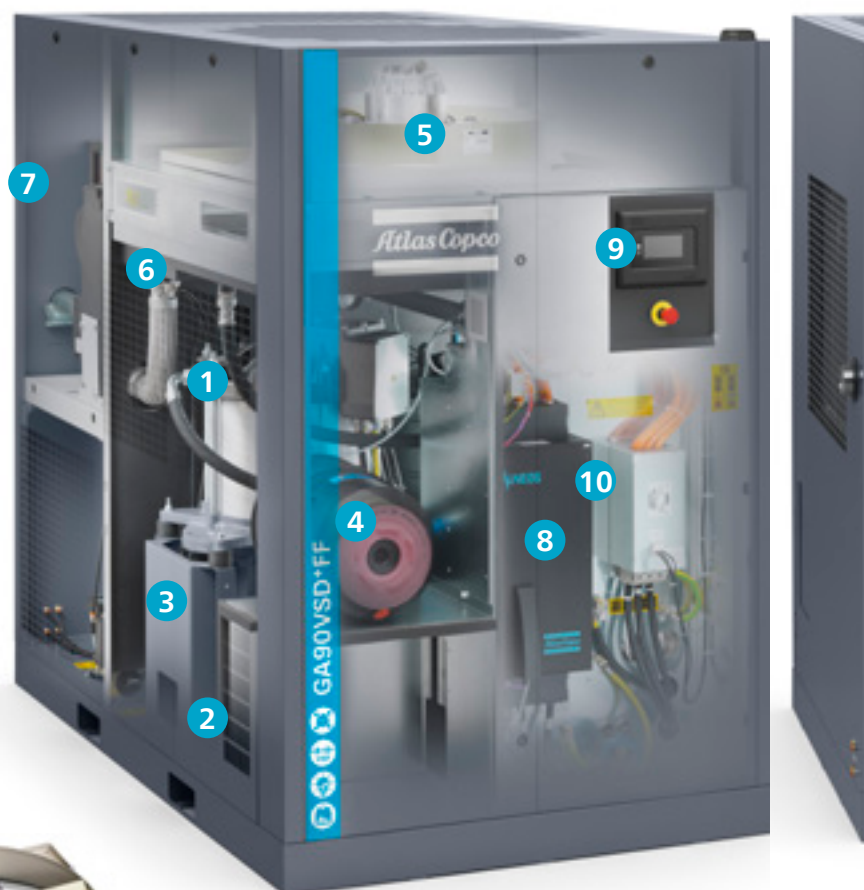

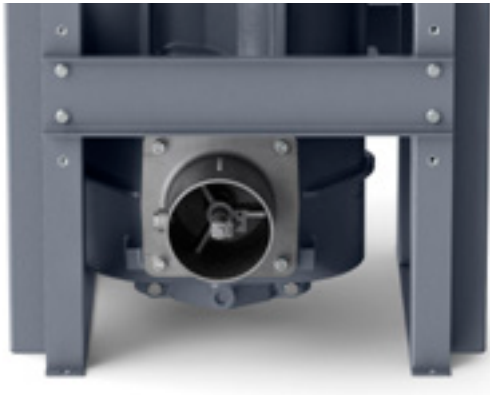

7 Integrated dryer

- Ensures excellence in air quality.
- Incorporates optional UD+ filter to meet ISO 8573-1 Quality Class 1.4.2.
- True plug-and-play design eliminates cost of installing a separate dryer.

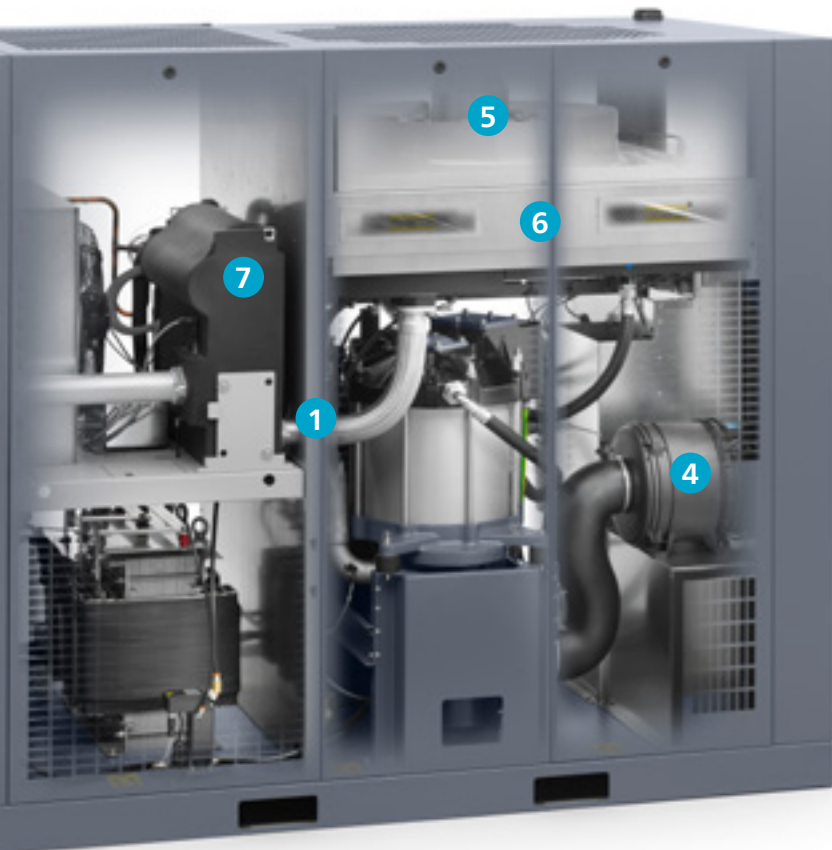

8 Innovative Neos inverter

- Atlas Copco's in-house designed inverter now also controls iPM motors.
- IP5x protection.
- Robust aluminum enclosure for trouble-free operation in the harshest conditions.
- Fewer components: compact, simple and user-friendly.

9 Elektronikon® Touch controller

- High-tech controller with warning indications, compressor shut-down and maintenance scheduling.
- Easy to use and designed to perform in the toughest conditions.
- Standard SMARTLINK remote monitoring to maximize air system performance and energy savings.
- Optional multiple compressor control (2, 4 or 6 compressors).



10 VSD+ Neos cubicle

- VSD+ is superior to idling machines.
- Electrical components remain cool, enhancing their lifetime.
- Dedicated Neos drive for iPM technology motors.
- Heat dissipation of inverter in separate compartment.



VSD+ for 50% average energy savings

Atlas Copco's GA Variable Speed Drive+ (VSD+) technology closely matches the air demand by automatically adjusting the motor speed. Combined with the innovative design of the iPM (Permanent Magnet) motor, this results in average energy savings of 50% and an average reduction of 37% in the lifecycle cost of a compressor.

Why Atlas Copco Variable Speed Drive+ technology?

- On average 50% energy savings with an extensive flow range (20-100%).
- Integrated Elektronikon® Touch controller controls the motor speed and high-efficiency frequency inverter.
- No wasted idling times or blow-off losses during operation.
- Compressor can start/stop under full system pressure without the need to unload.
- Eliminates peak current penalty during start-up.
- Minimizes system leakage due to a lower system pressure.
- EMC compliance to directives (2004/108/EG).

* Compared to fixed speed compressors, based on measurement performed by an independent energy audit agency.

In almost every production environment, air demand fluctuates depending on different factors such as the time of the day, week or even month. Extensive measurements and studies of compressed air demand profiles show that many compressors have substantial variations in air demand.

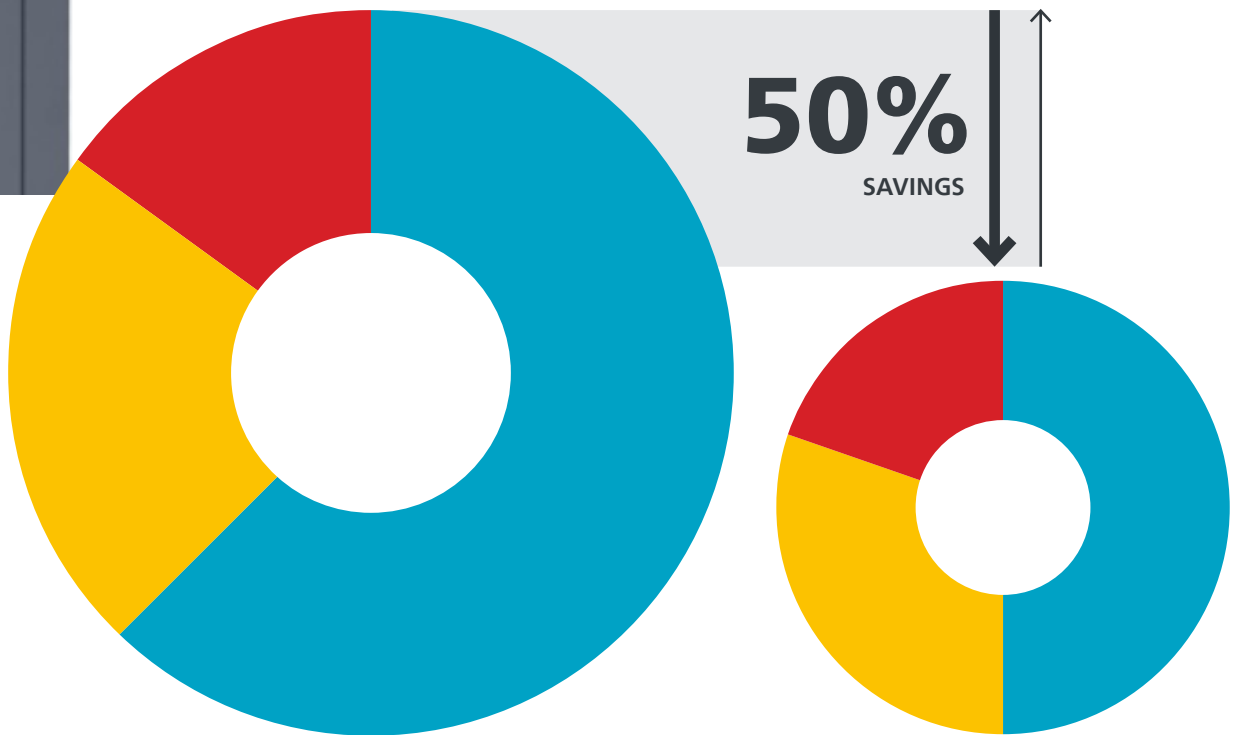
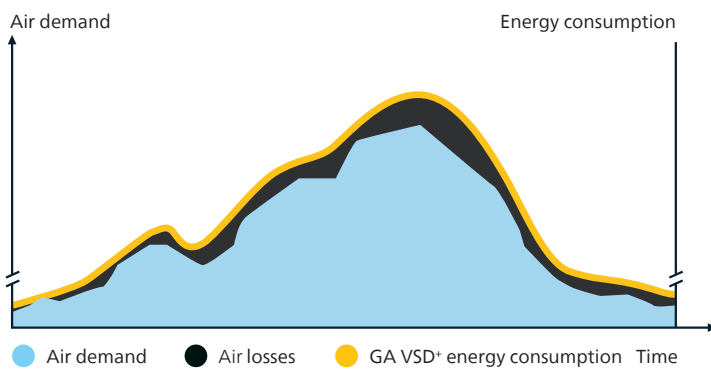
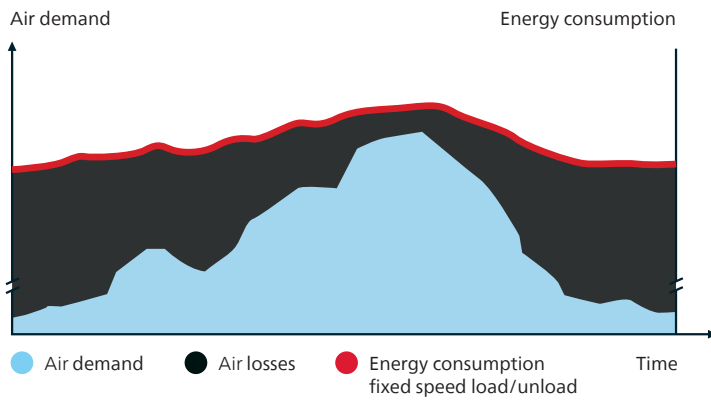

GA Fixed Speed

GA VSD+

● Investment ● Energy ● Maintenance

Advanced monitoring, control & connectivity

Whether you call it Industry 4.0 or the Internet of Things (IoT), interconnectivity is the future. The GA 37-110 VSD+ comes fully prepared. Its advanced monitoring, control and connectivity features allow you to optimize compressor performance, resources, efficiency and productivity.

Dual Pressure Set Point

Create two different system pressure settings to reduce energy use and costs during fluctuating demand.

Integrated Saver Cycles

Fan Saver Cycle reduces energy consumption by switching off the fan in light load applications.

Timer

A built-in clock supports any working schedule – per day, per week or customized to your specific situation and needs.

Control

The Elektronikon® Touch operating system gives you the control and monitoring options to optimize compressor performance. To maximize energy efficiency, the Elektronikon® controls the main drive motor and regulates system pressure within a predefined and narrow pressure band.

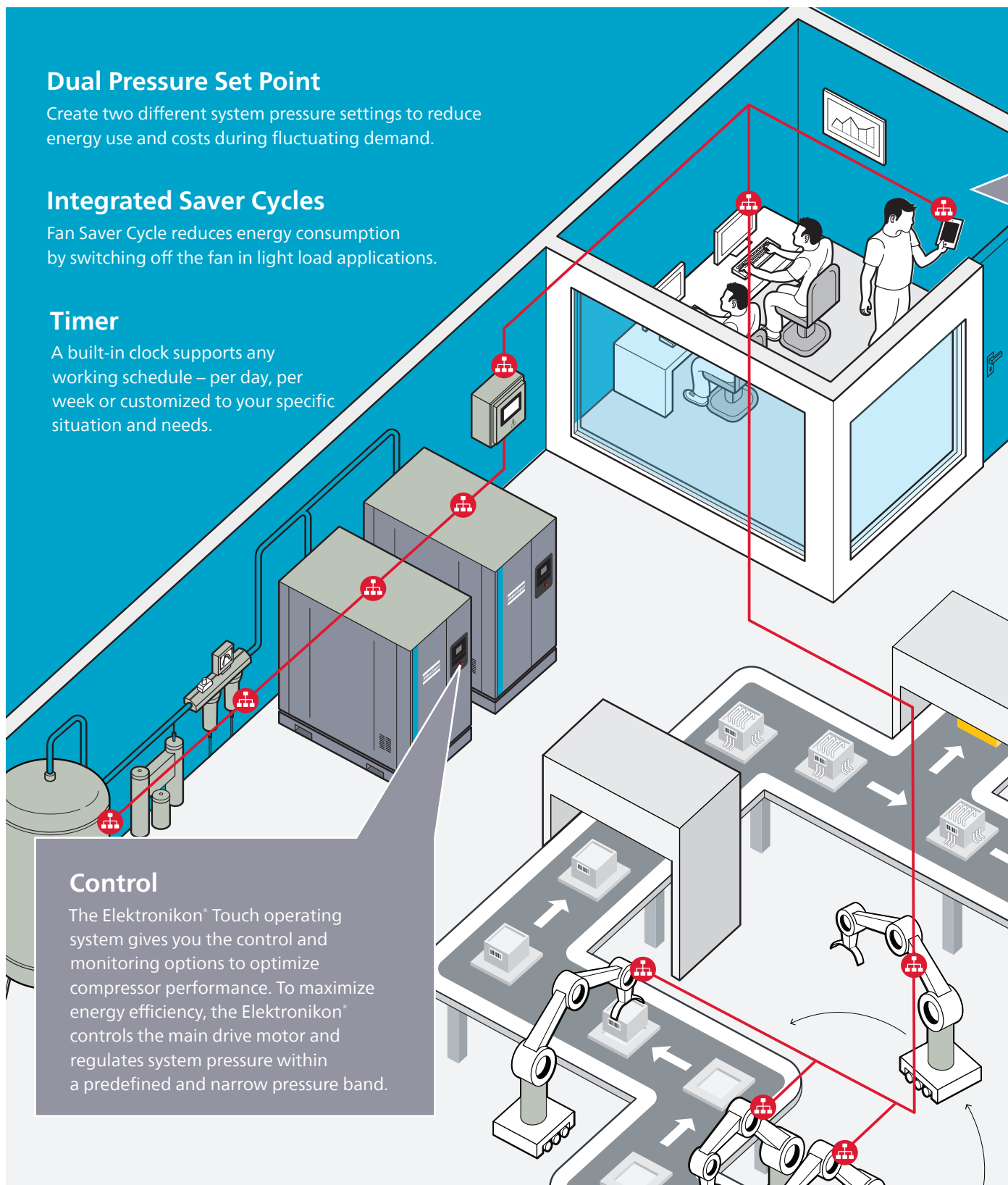

CONNECT

SMARTLINK*: Data Monitoring Program

- Remote monitoring that helps you optimize your compressed air system and save energy and costs.
- Provides a complete insight in your compressed air network.
- Anticipates potential problems by warning you upfront.

* Please contact your local sales representative for more information.

State-of-the-art Elektronikon® Touch controller



- ✓ Improved user-friendliness: 4.3-inch high-definition color display with clear pictograms and service indicator.
- ✓ Built-in SMARTLINK online monitoring.
- ✓ Increased reliability: new, user-friendly, multilingual user interface and durable touch screen.

Key features:

- Automatic restart after voltage failure.
- Internet-based compressor visualization using a simple Ethernet connection.
- Dual Pressure Set Point.
- More flexibility: four different week schedules that can be programmed for a period of 10 consecutive weeks.
- On-screen Delayed Second Stop function and VSD+ savings indication.
- Graphical service plan indication.
- Remote control and connectivity functions.
- Control up to 6 compressors by installing the optional equalizer central controller software.

Excellence in integrated air quality

Untreated compressed air contains moisture and aerosols which increase the risk of corrosion and compressed air system leaks. This can result in a damaged air system and contaminated end products. Maintenance costs can far exceed air treatment costs. The GA 37-110 VSD⁺ provides the clean, dry air that improves your system's reliability, avoids costly downtime and production delays, and safeguards the quality of your products.

On average 50% energy savings with newly designed integrated dryers

- Pressure dewpoint of 3°C/37.4°F (100% relative humidity at 20°C/68°F).
- Heat exchanger cross-flow technology with low pressure drop.
- Zero waste of compressed air thanks to no-loss condensate drain.
- Reduced operating costs.
- Environmentally-friendly characteristics: zero ozone depletion.
- Global warming potential has been lowered by an average of 50% by reducing the amount of refrigerant in the new dryer.



Meet your specific requirements

Thanks to its integrated dryer, the Atlas Copco GA 37-110 VSD⁺ offers the right air quality for your application.

Compressed air purity classification ISO 8573-1:2010

Purity class	Solid particles			Water		Total oil*
	Number of particles per m ³			Pressure dewpoint		Concentration
	0.1 < d ≤ 0.5 μm**	0.5 < d ≤ 1.0 μm**	1.0 < d ≤ 5.0 μm**	°C	°F	mg/m ³
0	As specified by the equipment user or supplier and more stringent than Class 1.					
1	≤ 20000	≤ 400	≤ 10	≤ -70	≤ -94	≤ 0.01
2	≤ 400000	≤ 6000	≤ 100	≤ -40	≤ -40	≤ 0.1
3	-	≤ 90000	≤ 1000	≤ -20	≤ -4	≤ 1
4	-	-	≤ 10000	≤ 3	≤ 37.4	≤ 5
5	-	-	≤ 100000	≤ 7	≤ 44.6	-
6	≤ 5 mg/m ³			≤ 10	≤ 50	-

* Liquid, aerosol and vapor.
 ** d= diameter of the particle.



Always at your service

Care for your compressed air

Compressed air is a vital part of your production process. However, keeping your air system running perfectly should not require too much of your time or attention. Leave it to the Atlas Copco service experts! We are here to help you with installation and commissioning, and the maintenance that best fits your needs. From the timely supply of service parts to taking full responsibility of your compressed air installation, we can ensure the reliable performance, maximum uptime and optimal efficiency you need.

The value of service

As a world player in compressed air solutions, we know how to best maintain and optimize your system. Our expert service technicians are highly trained in the smallest details of your installation as well as its overall performance. To protect your investment and ensure the integrity of your air system, they use genuine Atlas Copco spare parts only. Atlas Copco parts are delivered on-time, anywhere on the planet, through our world-class logistics organization.

Our monitoring capabilities enable us to spot issues before they become problems. Along with our customized audits, they offer insights in how to optimize your efficiency and reduce costs.

Call your service partner

We have more than 4,000 service engineers in over 160 countries. You are sure to find one just around the corner. Don't wait to discover the real value of our service offer: having your compressed air installation running optimally and efficiently, without interruptions and at minimal cost. Contact us today!

Technical specifications GA 37-110 VSD+

Compressor type	Max. working pressure		Capacity FAD* (min-max)			Installed motor power		Noise level**	Weight WorkPlace	Weight WorkPlace Full Feature
	bar(e)	psig	l/s	m ³ /h	cfm	kW	hp	dB(A)	kg	kg
GA 37 VSD+***	4	58	15-116	55-419	32-246	37	50	67	376	500
	7	102	15-115	53-413	31-243	37	50	67	376	500
	9.5	138	17-102	62-368	36-216	37	50	67	376	500
	12.5	181	16-87	59-312	35-183	37	50	67	376	500
GA 37L VSD+	4	58	26-133	94-479	55-282	37	50	67	860	1060
	7	102	26-132	93-475	55-279	37	50	67	860	1060
	9.5	138	25-116	89-418	53-246	37	50	67	860	1060
	12.5	181	38-99	138-355	81-209	37	50	67	860	1060
GA 45 VSD+	4	58	26-159	94-573	55-337	45	60	67	860	1060
	7	102	26-157	93-565	55-332	45	60	67	860	1060
	9.5	138	25-137	89-494	53-291	45	60	67	860	1060
	12.5	181	38-115	138-359	81-211	45	60	67	860	1060
GA 55 VSD+	4	58	26-189	93-680	55-400	55	75	67	900	1100
	7	102	26-188	94-677	55-399	55	75	67	900	1100
	9.5	138	26-166	93-598	55-352	55	75	67	900	1100
	12.5	181	40-140	145-504	85-297	55	75	67	900	1100
GA 75 VSD+	4	58	26-226	93-815	55-480	75	100	70	920	1120
	7	102	27-225	97-809	57-476	75	100	70	920	1120
	9.5	138	27-198	96-712	57-419	75	100	70	920	1120
	12.5	181	42-167	150-600	88-353	75	100	70	920	1120
GA 75L VSD+	4	58	47-269	169-967	100-569	75	100	73	1207	1496
	7	102	48-266	172-957	101-563	75	100	73	1207	1496
	9.5	138	58-235	210-847	124-498	75	100	73	1207	1496
	12.5	181	70-194	252-699	149-411	75	100	73	1207	1496
GA 90 VSD+	4	58	48-311	174-1121	102-660	90	125	74	1213	1503
	7	102	49-306	176-1101	104-648	90	125	74	1213	1503
	9.5	138	60-269	215-969	127-570	90	125	74	1213	1503
	12.5	181	71-218	255-784	150-461	90	125	74	1213	1503
GA 110 VSD+	4	58	47-348	170-1251	100-736	110	150	76	1222	1573
	7	102	49-345	175-1241	103-731	110	150	76	1222	1573
	9.5	138	59-309	211-1111	124-654	110	150	76	1222	1573
	12.5	181	71-268	254-965	150-568	110	150	76	1222	1573

* Unit performance measured according ISO 1217 ed. 4 2009, annex E, latest edition.

** Mean noise level measured at a distance of 1 m at max. working pressure according to ISO 2151: 2004 using ISO 9614/2 (sound intensity method); tolerance 3 dB(A).

*** This model is part of the GA 7-37 VSD+ range, a different series with different specifications.

FAD is measured at the following effective working pressures:

- 4 bar(e)
- 7 bar(e)
- 9.5 bar(e)
- 12.5 bar(e)

Maximum working pressure:

13 bar(e) (188 psig)

Reference conditions:

- Absolute inlet pressure 1 bar (14.5 psi).
- Intake air temperature 20°C/68°F.

Options

Energy recovery
Water-cooled version
High ambient version
IT ancillaries
Elektronikon® controller expansion module
Pre-filter
Tropical thermostat
Powerduct fan
UD* filter
FoodGrade oil
Roto Synthetic Xtend oil
EQ2i, EQ4i, EQ6i

Transformer included for 200-230-575V units



Dimensions	Standard						Full Feature					
	D (mm)	W (mm)	H (mm)	D (in)	W (in)	H (in)	D (mm)	W (mm)	H (mm)	D (in)	W (in)	H (in)
GA 37 VSD+	780	811	1590	30.71	31.93	62.60	780	1273	1590	30.71	50.12	62.6
GA 37L-75 VSD+	1100	1153	1968	43.31	45.39	77.48	1100	1656	1968	43.31	65.20	77.48
GA 75L-110 VSD+	1400	1300	1968	55.12	51.18	77.48	2178	1300	1968	85.75	51.18	77.48

Flow chart GA 37L-110 VSD+

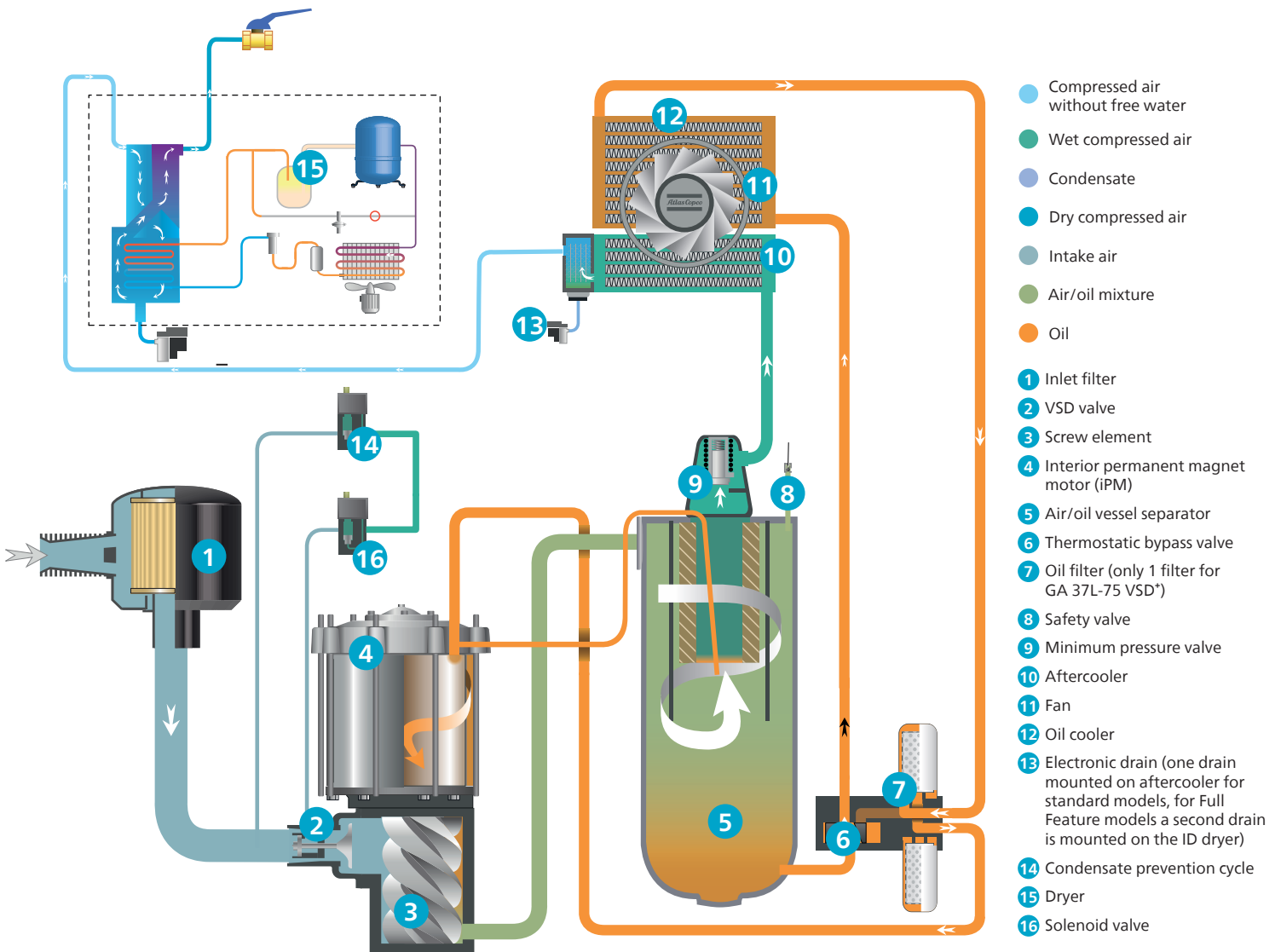

Recover and save energy

As much as 90% of the electrical energy used by a compressed air system is converted into heat. Using Atlas Copco's integrated energy recovery systems, you can recover up to $\approx 75\%$ of that power input as hot air or hot water without any adverse influence on the compressor's performance. Through efficient usage of the recovered energy, you generate important energy cost savings and a high return on investment.

Applications

- Auxiliary or main heating of warehouses, workshops...
- Industrial process heating.
- Water heating for laundries, industrial cleaning and sanitary facilities.
- Canteens and large kitchens.
- Food industry.
- Chemical and pharmaceutical industries.
- Drying processes.

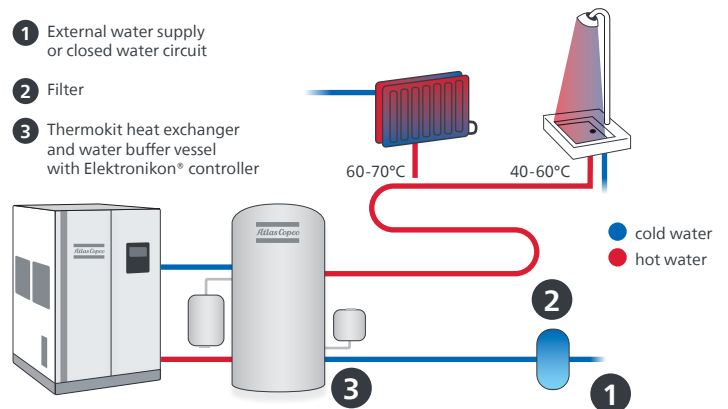



ISO 9001 · ISO 14001
OHSAS 18001

Atlas Copco

atlascopco.com

