

Atlas Copco



Air Line Infrastructure

Air Line Infrastructure



CONTENT

Air preparation units	03
Connectors and couplings	13
Hoses.....	39
Hose reels.....	49



AIR PREPARATION UNITS



Get the most out of your tools

- Get maximum productivity from your tools
- Extend the tool lifetime
- Lubricate your air tools
- Range covers all pneumatic tool needs

Selection guide

Types

Mini	Midi	Maxi
		
up to 29 l/s	up to 65 l/s	up to 200 l/s

Maximum air flow of FRL units

Air

preparation units



Air preparation unit **MINI-Range** main application is to prepare the air for pneumatic components.

MINI-K units have a 1/4" BSP connection thread, are ideal for small tooling applications.

Working temperature
-10°C to 50°C

Max Working Pressure
10 bar (232 psi)

DESCRIPTION
Sinter filter centrifugal principle, diaphragm-type pressure with relieving feature, lubricator with automatic oil filling.

Medium
Compressed air and neutral gases

SUPPLY Pressure
1.5 - 16 bar at inlet

0.5 - 10 bar at outlet

FILTER ELEMENT

5µm

Model	Maximum air flow l/s	Bowl material	Filter condensate drainage	Max condensate capacity cm ³	Max capacity cm ³	Weight kg	Ordering No.
Filters							
MINI-FIL-1/4-BSP	37	Plastic, PC with PA bowl guard	Automatic	10	-	0.28	4221 0001 31
Regulators							
MINI-REG-1/4-BSP	34	-	-	-	-	0.3	4221 0001 39
Lubricators							
MINI-LUB-1/4-BSP	46	Plastic, PC with PA bowl guard	-	-	40	0.28	4221 0001 47
Filter/regulator							
MINI-F/R-1/4-BSP	34	Plastic, PC with PA bowl guard	Automatic	10	-	0.48	4221 0001 55
Filter/regulator+lubricator							
MINI-FRL-1/4-BSP	29	Plastic, PC with PA bowl guard	Automatic	10	40	0.78	4221 0001 63

NOTE: All separate units, mounting brackets, assembly kits and pressure gauges need to be ordered separately. F/R and FRL units are delivered with gauge. Wall brackets are available for each unit but need to be ordered separately based on your needs. Mounting plate is available to be ordered for Pressure Regulator & filter pressure regulator.



The **MIDI Range** is suitable for more than 90% of the Atlas Copco tool range and is the best choice for assembly tools, percussive tools, drills, nibblers and grinders up to Turbo.

The **MIDI Optimizer** has a 1/2" BSP connection thread and a housing and bowl of high-tech polymer.

Working temperature

-10 °C to 50°C
+2°C to +60°C at 10 bar for filters

NOTE: For dry compressed air, ice formation must be avoided.

DESCRIPTION

Sinter filter centrifugal principle, diaphragm-type pressure with relieving feature, lubricator with automatic oil filling.

Medium

Compressed air, neutral gases

SUPPLY Pressure

1.5 - 16 bar at inlet

0.5 - 10 bar at outlet

FILTER ELEMENT

5µm

Model	Maximum air flow l/s	Bowl material	Filter condensate drainage	Max condensate capacity cm ³	Max capacity cm ³	Weight kg	Ordering No.
Filters							
MIDI-FIL-1/2-BSP	59	Plastic, PC with PA bowl guard	Automatic	31	-	0.43	4221 0001 33
Regulators							
MIDI-REG-1/2-BSP	83	-	-	-	-	0.49	4221 0001 41
Lubricators							
MIDI-LUB-1/2-BSP	134	Plastic, PC with PA bowl guard	-	-	80	0.4	4221 0001 49
Filter/regulator							
MIDI-F/R-1/2-BSP	83	Plastic, PC with PA bowl guard	Automatic	31	-	0.66	4221 0001 57
Filter/regulator+lubricator							
MIDI-FRL-1/2-BSP	65	Plastic, PC with PA bowl guard	Automatic	31	80	1.16	4221 0001 65

NOTE: All separate units, mounting brackets, assembly kits and pressure gauges need to be ordered separately. F/R and FRL units are delivered with gauge. Wall brackets are available for each unit but need to be ordered separately based on your needs. Mounting plate is available to be ordered for Pressure Regulator & filter pressure regulator.

Air

preparation units



The high flow **MAXI air** preparation unit's main application is to prepare the air for pneumatic tools which are large air consumers when long distribution hoses and multi connectors are used. A good example is Atlas Copco Turbo grinders.

Working temperature

-10°C to 50°C

NOTE: For dry compressed air, ice formation must be avoided.

Max Working Pressure

10 bar (232 psi)

DESCRIPTION

Sinter filter centrifugal principle, diaphragm-type pressure with relieving feature, lubricator with automatic oil filling.

Medium

Compressed air, neutral gases.

SUPPLY Pressure

1.5 - 16 bar at inlet

0.5 - 10 bar at outlet

FILTER ELEMENT

5µm

Model	Maximum air flow l/s	Bowl material	Filter condensate drainage	Max condensate capacity cm ³	Max capacity cm ³	Weight kg	Ordering No.
Filters							
MAXI-FIL-3/4-BSP	134	Plastic, PC with PA bowl guard	Automatic	69	-	0.9	4221 0001 35
MAXI-FIL-1-BSP	134	Plastic, PC with PA bowl guard	Automatic	69	-	0.8	4221 0001 37
Regulators							
MAXI-REG-3/4-BSP	237	Plastic, PC with PA bowl guard	-	-	-	1.02	4221 0001 43
MAXI-REG-1-BSP	237	Plastic, PC with PA bowl guard	-	-	-	0.95	4221 0001 45
Lubricators							
MAXI-LUB-3/4-BSP	234	Plastic, PC with PA bowl guard	-	-	181	0.95	4221 0001 51
MAXI-LUB-1-BSP	234	Plastic, PC with PA bowl guard	-	-	181	0.89	4221 0001 53
Filter/regulator							
MAXI-F/R-3/4-BSP	217	Plastic, PC with PA bowl guard	Automatic	69	-	1.29	4221 0001 59
MAXI-F/R-1-BSP	217	Plastic, PC with PA bowl guard	Automatic	69	-	1.29	4221 0001 61
Filter/Regulator/Lubricator							
MAXI-FRL-3/4-BSP	200	Plastic, PC with PA bowl guard	Automatic	69	181	2.35	4221 0001 67
MAXI-FRL-1-BSP	200	Plastic, PC with PA bowl guard	Automatic	69	181	2.22	4221 0001 69

NOTE: All separate units, mounting brackets, assembly kits and pressure gauges need to be ordered separately. F/R and FRL units are delivered with gauge. Wall brackets are available for each unit but need to be ordered separately based on your needs. Mounting plate is available to be ordered for Pressure Regulator & filter pressure regulator.

Single Filter Accessories

Designation	Ordering No.
Semi/Manual Drain: for MINI series	4221 0001 75
Autodrain: for all three ranges	4221 0001 76
Metal filter bowl with level indicator and automatic drain (P1 max 10 bar)	
MINI series	4221 0002 04
MIDI series	4221 0002 05
MAXI series	4221 0002 07

Single Regulator Accessories

Designation	Ordering No.
Pressure Gauge 1: Standard (Metal material) BSP	4221 0001 77

Single Lubricator Accessories

Designation	Ordering No.		
	MINI	MIDI	MAXI
Metal bowl with level indicator and fill valve (Die cast, Zinc)			
	4221 0001 80	4221 0001 81	4221 0001 82

Filter, Regulator and Lubricator Accessories

Designation	Ordering No.
MINI	
Coupling kit - (Steel, for wall mounting, 2 pcs)	4221 0001 83
Mounting bracket - (Steel, mounting on top of regulator, incl. nut, 1 pcs)	4221 0001 84
Coupling kit - (for connecting FR+L units, 1 pcs)	4221 0001 85
MIDI	
Coupling kit - (Steel, for wall mounting, 2 pcs)	4221 0001 86
Mounting bracket - (Steel, mounting on top of regulator, incl. nut, 1 pcs)	4221 0001 87
Coupling kit - (for connecting FR+L units, 1 pcs)	4221 0001 88
MAXI	
Coupling kit for 1" FRL - (Steel, for wall mounting, 2 pcs)	4221 0001 89
Coupling kit - (for connecting FR+L units, 1 pcs)	4221 0001 90
Coupling for 3/4" FRL - (Steel, for wall mounting, 2 pcs)	4221 0002 00

NOTE: Mounting Plate can't be used with Maxi units due to weight of the unit.
The Auto Drain fits to the complete FRL range and is already factory mounted on the complete FRL range.

Ball Valve (Lockable)

Designation	Ordering No.
Size MINI 1/4"	8202 1350 63
Size MIDI 1/2"	8202 1350 64
Size MAXI 3/4"	8202 1350 65
Size MAXI 1"	8202 1350 66

Mounting examples

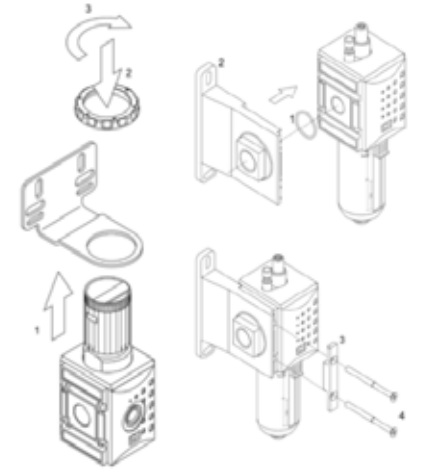

Semi/manual drain

Autodrain



Metal lubricator bowl



Metal lubricator bowl



pressure gauge standard



Coupling kit for the wall



Mounting bracket for the wall



Coupling kit for connection FR+L



Ball valve



Air

preparation units

Optimizer Air Tool Oil

Atlas Copco Optimizer air tool oil is a white, oil based lubricant for pneumatic tools. It has excellent antiwear properties and contains additives preventing oxidation and foaming. Optimizer air tool oil provides a better working environment, compared to conventional mist lubrication oils and is recommended when stringent demands are placed on the working environment.

- Provides a better working environment.
- Excellent antiwear properties.
- Minimizes wear on components.



Designation	Ordering No.
Optimizer 0.5 liter	090 0000 02
Optimizer 1 liter	9090 0000 04
Optimizer 4 liter	9090 0000 06

Technical Data

Temperature range: -25°C to +70°C
Density at 15°C: 869 kg/m³
Viscosity at 40°C: 22 mm²/s
Pour point: -48°C
Flash point COC: >170°C

SINGLE POINT LUBRICATOR DOSOL

Accurate lubrication for tools in intermittent service.

The Atlas Copco DOSOL system for direct lubrication is based on an injector pump which meters out the oil in exact doses, actuated by pulses of compressed air. The oil dosage can be regulated from a fraction of a drop to a full drop.

- **Exact amount** – Precision injector, adjustable for exact amount of oil.
- **Oil directly at the tool** – The oil is conveyed through a capillary tube directly to the lubrication point.



A single-point lubricator (SPL) consists of an injector pump fitted to a valve body, converting interruptions in compressed air flow into pulses. In the majority of cases, an oil bowl is fitted on each lubricator.

Every DOSOL SPL unit can be finely tuned to inject from 1 to 1/10 of a drop of oil in 40 steps (30 to 3 mm³). Every DOSOL SPL unit includes as standard a counter with a switch that allows the lubricator to operate every first, fifth or tenth tool cycle.

The adjusting knob features a positive stop at both maximum and minimum settings, which means that a zero setting is not possible.

The preset quantity of oil is supplied to the tool through a small-bore nylon tube inside the air hose. 7.5 m of oil-filled nylon tubing is included as standard.

MULTIPLE-POINT LUBRICATOR DOSOL

For supplying lubricant to an unlimited number of lubrication points on a machine or in a pneumatic system.

The DOSOL multiple-point lubricator (MPL) consists of a number of JECT 01 oil metering pumps assembled into a "package" with a common BASE base-plate. A stack may contain up to ten JECT 01 units. Several such assemblies may be used together.

- All oil pumps are supplied with oil via the BASE from an oil container or central oil reservoir. A line for pneumatic signals from the equipment to be lubricated

is also connected to the BASE.

- The lubricant is conveyed through small-bore nylon tubing which should be ended with check valves.
- With the TEN counter the lubricator can be actuated every first, fifth or tenth tool cycle.

Every DOSOL MPL unit can be finely tuned to inject from 1 to 1/10 drop of oil in 40 steps (30 to 3 mm³). This helps to minimize the oil dose. The adjusting knob features a positive stop at both maximum and minimum settings, which means that zero setting is not possible.

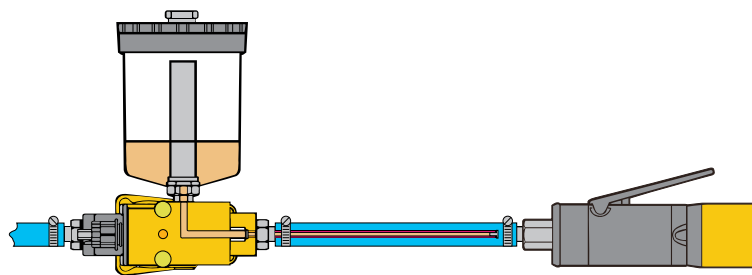

Single-Point Lubricator, Dos

Model	Connection thread BSP	Air flow l/s		Working pressure bar		Temperature range °C		Ordering No.
		in	min	max ^a	min	max	min	
DOS 15B-C ^b	1/2	2.3	45	3.2	10	-30°	+60°	8202 4201 73
DOS 15B-CR ^c	1/2	2.3	45	3.2	10	-30°	+60°	8202 4202 72
DOS 20B-CR ^c	3/4	2.3	53	3.2	10	-30°	+60°	8202 4202 80

^a At 6 bar and ΔP = 0.2 bar.

^b With counter and 7.5 m oil-filled nylon tubing.

^c With 0.3 l oil container counter and 7.5 m oil-filled nylon tubing.

Air

preparation units

Lubricator DOSOL - accessories

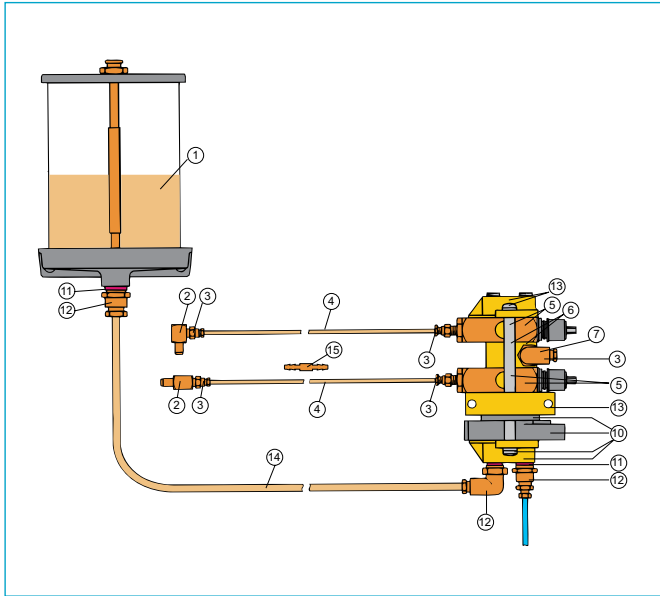

NOTE: When the counter TEN is used in MPL installations an intermediate, black plastic part is used (supplied with all TEN counters) between BASE and TEN.

TEN-counter

When lubricating equipment with a very low air consumption or very short time in operation it may be difficult to set a sufficiently small dose of oil. In such cases a counter is connected underneath the base plate BASE. The oil pumps will then be actuated only on each, every fifth or every tenth air pulse. The air signal is connected to the clamp underneath the counter.

Ordering No. 8202 4206 03

Side-ported air block kit

If all pumps are not to be actuated simultaneously, a signal block is installed between the oil pumps in the stack. The pumps below the signal block will then be actuated via the base plate BASE and those above it from a separate signal via the signal block.

Ordering No. 8202 4206 03

For single point lubricator dosol

Designation	Ordering No.
Nylon tubing 3.2 mm outside diameter	
7.5 m, oil-filled	9090 1418 00
7.5 m, without oil	9090 1419 00
100 m, with oil	9090 1420 00
Barbed nipple for joining of 3.2 mm tubes	9090 1423 00
Check valve for outer end of nylon tubing, dia ext. 3.2 mm	9090 2050 00

Multiple-Point Lubricator, Base, Ject 01

Designation	BSP in	Ordering No.
BASE baseplate	Plate	8202 4205 04
	Oil port	1/4
	Air port	1/4
	Clamp	
	Oil port	1/4
	Air port	1/4
JECT 01 oil pump	Oil delivery port	1/8 8202 4203 10

Ref No. in figure	Designation	Ordering No.
1	Oil container	
	0.3 l for direct mounting	9090 1415 00
	0.95 l for wall mounting (1/4" BSP female)	
	1.9 l for wall mounting (1/4" BSP female)	
2	Check valve	
	1/8" BSPT 90° elbow male x 1/8" BSP female	9090 1427 00
	1/8" BSPT, straight male x 1/8" BSP female	9090 1426 00
3	Male adapter 1/8" BSPT, straight for	
	tube outer diameter 3.2 mm	9090 1425 00
4	Capillary tubing	
	7.5 m, outer dia. 3.2 mm prefilled with oil	9090 1418 00
	7.5 m, outer dia. 3.2 mm without oil	9090 1419 00
	100 m, outer dia. 3.2 mm with oil	9090 1420 00
5	JECT 01 kit ^a	8202 4203 10
6	Side-ported air block kit	
7	Fiber packing for 1/8" BSP	0657 5742 00
10	Counter TEN kit	8202 4206 03
11	Fiber packing for 1/4" BSP	0657 5764 00
12	Male adapter 1/4" BSP, straight for	9090 0715 00
13	BASE kit	8202 4205 04
14	Nylon tube, outer diameter 8 mm (sold by the meter)	9030 0060 00
15	Barbed nipple for joining of nylon tubes outer diameter 3.2 mm	9090 1423 00
16	Nylon tube outer diameter 5 mm (sold by the meter)	

^a With high temperature Viton seals 8202 4203 15.



Atlas Copco Inline Testing Equipment

comes in EU, US and ASIA Profile Series.

The test equipment is :

1. Easy to Use
2. Fast and Reliable
3. Real Time Feedback Pressure at Tool Inlet

Just connect this device between power tool and hose and check air pressure dynamically while the tool is working.

Model	Nip Standard	Max working pressure	Connection type	Part Number
Atlas Copco IPT-SmartQic 08E	EURO STANDARD 7.6	16 bar	Nipple 1/4" male	4221000496
Atlas Copco IPT-SmartQic 15E	EURO STANDARD 10.4	16 bar	Nipple 3/8" male	4221000501
Atlas Copco IPT-SmartQic 08US	ISO 6150-B / US STANDARD	16 bar	Nipple 1/4" male	4221000502
Atlas Copco IPT-SmartQic 10US	ISO 6150-B / US STANDARD	16 bar	Nipple 3/8" male	4221000504
Atlas Copco IPT-SmartQic 15US	ISO 6150-B / US STANDARD	16 bar	Nipple 3/8" male	4221000505
Atlas Copco IPT-SmartQic 10A	ASIA STANDARD 7.5 MM	16 bar	Nipple 3/8" male	4221000506

CONNECTORS AND COUPLINGS

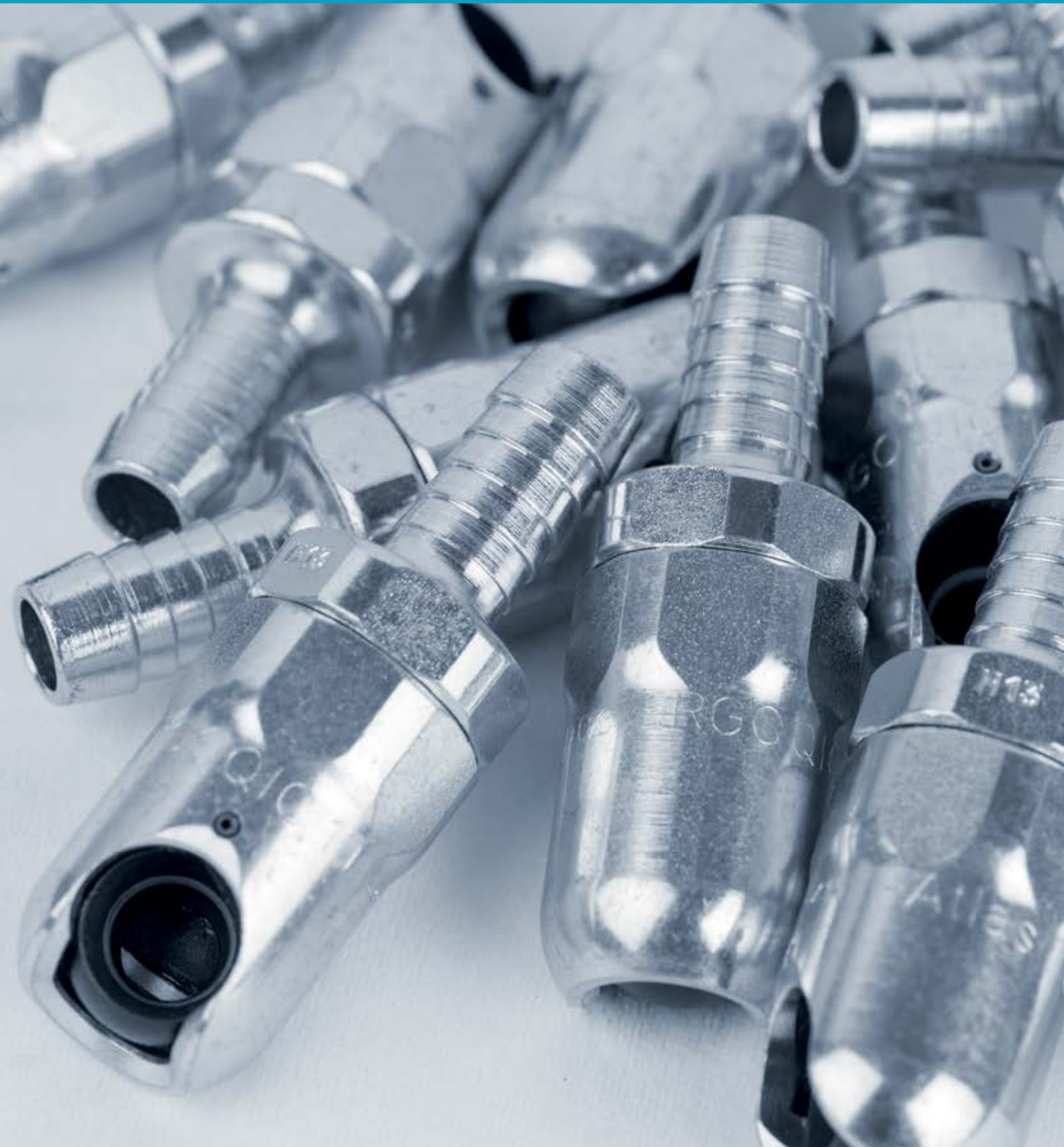

Whenever tools or pneumatic equipment need to be changed, or you need to make quick connections of hoses to an air outlet, Atlas Copco couplings are the energy efficient, high productivity choice.

All Atlas Copco couplings are designed to ensure minimum pressure drop and thus reduce energy consumption. The exceptionally high air flow ensures full power to your tools.

The couplings are light and compact and the bodies are made of hardened steel, which provides long life in the toughest applications.



**Contact us
to get a manual
nip/coupling selector**

Selection guide

Ensure the highest air flow and lowest pressure drop of your pneumatic tools

Whenever tools or pneumatic equipment need to be changed, or you need to make quick connections of hoses to an air outlet, Atlas Copco couplings are the energy efficient and high productivity choice.

Energy efficiency	Ergonomics	The range
All Atlas Copco couplings are designed to ensure minimum pressure drop and thus reduce energy consumption.	The couplings from Atlas Copco features compact dimensions and low weight for the operator.	Atlas Copco offers four product groups of quick couplings in many international standards:
Productivity	Safety	<ul style="list-style-type: none"> ErgoQIC - full flow coupling. SmartQIC - Safety vented coupling. QIC - Entry level coupling. Claw - High flow and durable coupling.
Exceptionally high air flow ensures full power to your tools.	ErgoQIC and SmartQIC are vented safety versions to minimize the risk of sudden component separation and sound bang. The safety features are according to EN 983 and ISO 4414.	
Quality		
Atlas Copco couplings are light and compact and the bodies are made of hardened steel, which provides long life in the toughest applications.		

Selection Guide

Standard	Global Standard			Euro Standard			US standard / ISO 6150-B			Asia Standard
Type				7.6 (7.4) mm	10.4 mm	15 mm	5.3 mm(1/4")	8.2 mm(3/8")	11 mm (1/2")	7.5
Atlas Copco ErgoQIC	08	10	10AC	08E	15E		08US	10US	15US	10 A
Atlas Copco SmartQIC				08E	15E		08US	10US	15US	10A
Atlas Copco QIC			10			15	08			
Atlas Copco Claw	Claw									
CEJN				320	410		310	430	550	315
Oetiker				SC C			SC B1	SC E	SC H	SC D
Tema		1650		1600	1700	1750	1400			
Rectus		33		25/26	27	34	23/24	30	37	13
Prevost				ECS/ERC07			IRC/ISC06	IRC/ISC08	ISG 11	ORG
Nitto Kohki										20/30/40
Amflo							C20B	C26	C10	
Bosch				7.2						
Parker					55		30/B23	25F	17	
Foster							3003	4404	5205	
Abnox				x						
Afnor NF 49053							x	x	x	
Camozzi				508/5180						
Dynaquip							1/4"	3/8"		
EWO				x						
Festo				KD						
Gromelle							600	900		
Hansen							22/3000	400/4000	500/5000	
Ingersoll Rand				757			A2/MS/102	A3/103/203	A4/104/204	
Kaeser				x						
Lengris				25/26	27		23/24	30		13
Tomco							180	4000	5000	







Maximize your productivity!

Select full flow couplings from Atlas Copco

- Recommended by Atlas Copco for your application and tool.



ErgoQIC 08US	ErgoQIC 08 ErgoQIC 10AC	ErgoQIC 10A	ErgoQIC 08E	ErgoQIC 10US	ErgoQIC 10	ErgoQIC 15E	ErgoQIC 15US
Air flow capacity 0-11 l/s	Air flow capacity 0-18 l/s	Air flow capacity 0-22 l/s	Air flow capacity 0-24 l/s	Air flow capacity 0-27 l/s	Air flow capacity 0-40 l/s	Air flow capacity 0-49 l/s	Air flow capacity 0-52 l/s

	Bolt size	Air flow requirements	ErgoQIC 08US	ErgoQIC 08 ErgoQIC 10AC	ErgoQIC 10A	ErgoQIC 08E	ErgoQIC 10US	ErgoQIC 10	ErgoQIC 15E	ErgoQIC 15US
	Screwdrivers	M2-M6	2-8 l/s	•	•	•	•			
	Impact wrenches	1/4" HEX and 3/8"	2-9 l/s	•	•	•	•			
		3/8" and 1/2"	10-20 l/s					•	•	
	Pulse tools	M4-M5	28-37 l/s	•	•	•	•			
		M6-M12					•	•	•	
		M14-M20						•	•	•
Power										
	Drills	<820 W	8-21 l/s	•	•	•	•			
	Size									
	Chipping hammers	<7 Kg	6.5-14 l/s	•	•	•	•			
		Power								
	Die grinders	<500 W	3-10 l/s	•	•	•	•			
		500-900 W	7-19 l/s					•	•	
		0.9-2 kW	20-35 l/s					•	•	•
	Turbine grinders	<2.5 kW	32 l/s					•	•	•
	Blow guns		4-7.5 l/s	•	•	•	•			

SmartQIC

SMARTQIC is the latest generation of pneumatic safety couplings and nipples. The couplings offers high flow and low pressure drop with innovative safety features. The design has a unique safety venting feature when disconnecting, thus minimizing risk of injury to the operator.

Durable and tough, the couplings are made out of zinc-plated steel/brass material and the entire product range complies with safety standards ISO 4414 and EN 983. SMARTQIC couplings also complies with OSHA 1910.95. Suitable for many types of applications and pneumatic tools; such as screwdrivers, assembly tools, drills and grinders.



ErgoQIC

The ErgoQIC coupling is a ball valve coupling with a safety feature offering a higher flow than ordinary coupling systems. The ErgoQIC is a strong and durable full flow quick coupling with no air restriction inside the coupling. It is suitable for assembly tools, drills and grinders. Upgrading any air system with ErgoQIC will give the benefits of productivity and energy efficiency. ErgoQIC is designed to minimize the risk of sudden component separation and sound bang. The safety features are according to EN 983 and ISO 4414. It is made of hardened steel. The ErgoQIC disconnects in two steps; first you push in and bend slowly – the pressurized air hose will then vent, and as a second step you can disconnect without risk of harming the operator.

MultiFlex Swivel

MultiFlex Swivel is a multi-directional connector. Once the tool is connected the hose will stay in the ideal position however much the operator and the tool move around. The MultiFlex bends and rotates 360° in all directions while the hose stays straight.



Claw

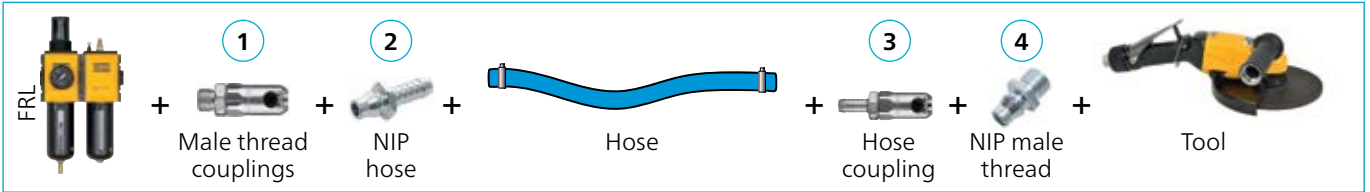

CLAW couplings are made from dropforged, hardened steel which can withstand rough treatment and ensures a long life even under difficult conditions. The coupling head is the same for all hose sizes, which can therefore be freely combined. The recommended maximum working pressure is 10 bar.

How to...

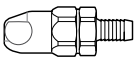
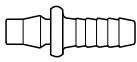
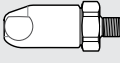
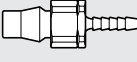
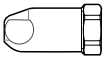

NOTE: Most Atlas Copco tools come with a female thread, please check the tread before choosing your coupling and nip selection. Same selection process can be used for all couplings e.g. SmartQic; ErgoQic, etc.

EXAMPLE

Connection type	Coupling ErgoQIC 10	Ordering No.	Size		Connection type	Nipple ErgoNIP10	Ordering No.	Size	
			mm	in				mm	in
H-Hose 	H06	8202 1120 30	6.3	1/4	H-Hose 	H06	8202 1220 35	6.3	1/4
	H08	8202 1120 40	8	5/16		H08	8202 1220 43	8	5/16
	H10	8202 1120 02	10	3/8		H10	8202 1220 50	10	3/8
	H13	8202 1120 10	12.5	1/2		H13	8202 1220 68	12.5	1/2
	H16	8202 1120 50	16	5/8		H16	8202 1220 76	16	5/8
	H20	8202 1120 60	19	3/4		H20	8202 1220 77	19	3/4
M-Male 	M08	8202 1120 85	1/4 BSP		SH-Safety Hose^a 	SH06	8202 1220 37	6.3	1/4
	M10	8202 1120 93	3/8 BSP			SH08	8202 1220 45	8	5/16
	M15	8202 1120 97	1/2 BSP			SH10	8202 1220 52	10	3/8
	M20	8202 1120 98	3/4 BSP			SH13	8202 1220 70	12.5	1/2
	M25	8202 1120 99	1 BSP			SH16	8202 1220 74	16	5/8
F-Female 	F08	8202 1121 00	1/4 BSP		M-Male 	M08	8202 1220 01	1/4 BSP	
	F10	8202 1121 05	3/8 BSP			M10	8202 1220 19	3/8 BSP	
	F15	8202 1121 10	1/2 BSP			M15	8202 1220 27	1/2 BSP	



08
Nipple profile

ErgoQIC 08

ATLAS COPCO GLOBAL STANDARD

The ErgoQIC 08 is a full flow quick coupling with no air restriction inside the coupling. It is suitable for assembly tools, drills and small grinders. Upgrading any air system with ErgoQIC 08 will give the benefits of productivity and energy efficiency.

- Full flow coupling.
- Ergonomic design, small size and low weight.
- Strong and durable.
- Safety feature according to EN 983 / ISO 4414.
- Protective rubber cover available.
- Main market: Global.

Technical Data

Max flow capacity	29 l/s (0.5 bar ΔP)
Economical air flow	18 l/s (0.2 bar ΔP)
Max working pressure	16 bar
Temperature range	-10°C to +70°C



10
Nipple profile

ErgoQIC 10

ATLAS COPCO GLOBAL STANDARD



The ErgoQIC 10 is a full flow coupling with no air restriction inside the coupling. It is suitable for assembly tools, drills and grinders. Upgrading any air system with ErgoQIC 10 will give the benefits of productivity and energy efficiency.

- Extreme full flow coupling.
- Strong and durable.
- Minimized connection force.
- Safety feature according to EN 983 / ISO 4414.
- Protective rubber cover available.
- Main market: Global.

Technical Data



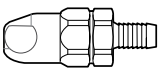
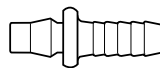
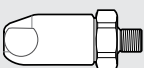
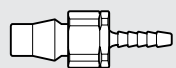
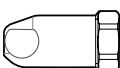
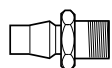

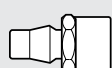
Max flow capacity	60 l/s (0.5 bar ΔP)
Economical air flow	40 l/s (0.2 bar ΔP)
Max working pressure	16 bar
Temperature range	-10°C to +70°C

ErgoQIC 08 and ErgoNIP 08, 18 l/s (recommended air flow at 6.3 bar pressure)

Connection type	Coupling ErgoQIC 08	Ordering No.	Size		Connection type	Nipple ErgoNIP 08	Ordering No.	Size	
			mm	in				mm	in
	H06	8202 1110 04	6.3	1/4		H05	8202 1210 33	5	3/16
	H08	8202 1110 12	8	5/16		H06	8202 1210 37	6.3	1/4
	H10	8202 1110 38	10	3/8		H08	8202 1210 45	8	5/16
	H13	8202 1110 40	12.5	1/2		H10	8202 1210 52	10	3/8
	M08	8202 1110 61	1/4 BSP		SH06	8202 1210 39	6.3	1/4	
	M10	8202 1110 79	3/8 BSP		SH08	8202 1210 47	8	5/16	
	M15	8202 1110 87	1/2 BSP		SH10	8202 1210 50	10	3/8	
						SH13	8202 1210 55	12.5	1/2
	F08	8202 1110 90	1/4 BSP		M06	8202 1210 03	1/8 BSP		
	F10	8202 1110 95	3/8 BSP		M08	8202 1210 11	1/4 BSP		
		9090 1940 00			M10	8202 1210 29	3/8 BSP		
					M15	8202 1210 31	1/2 BSP		
					F08	8202 1210 60	1/4 BSP		
					F10	8202 1210 62	3/8 BSP		

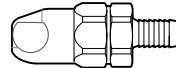
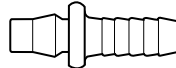
^a For joining hoses longer than 3 meters.

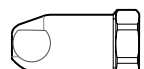
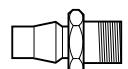
ERGOQIC 10 AND ERGONIP 10, 40 L/S (recommended air flow at 6.3 bar pressure)

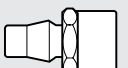
Connection type	Coupling ErgoQIC 10	Ordering No.	Size		Connection type	Nipple ErgoNIP 10	Ordering No.	Size	
			mm	in				mm	in
	H06	8202 1120 30	6.3	1/4		H06	8202 1220 35	6.3	1/4
	H08	8202 1120 40	8	5/16		H08	8202 1220 43	8	5/16
	H10	8202 1120 02	10	3/8		H10	8202 1220 50	10	3/8
	H13	8202 1120 10	12.5	1/2		H13	8202 1220 68	12.5	1/2
	H16	8202 1120 50	16	5/8		H16	8202 1220 76	16	5/8
	H20	8202 1120 60	19	3/4		H20	8202 1220 77	19	3/4
	M08	8202 1120 85	1/4 BSP		SH06	8202 1220 37	6.3	1/4	
	M10	8202 1120 93	3/8 BSP		SH08	8202 1220 45	8	5/16	
	M15	8202 1120 97	1/2 BSP		SH10	8202 1220 52	10	3/8	
	M20	8202 1120 98	3/4 BSP		SH13	8202 1220 70	12.5	1/2	
	M25	8202 1120 99	1 BSP		SH16	8202 1220 74	16	5/8	
						SH20	8202 1220 75	19	3/4
	F08	8202 1121 00	1/4 BSP		M08	8202 1220 01	1/4 BSP		
	F10	8202 1121 05	3/8 BSP		M10	8202 1220 19	3/8 BSP		
	F15	8202 1121 10	1/2 BSP		M15	8202 1220 27	1/2 BSP		
		9090 1931 00			F08	8202 1220 84	1/4 BSP		
					F10	8202 1220 86	3/8 BSP		
					F15	8202 1220 88	1/2 BSP		

^a For joining hoses longer than 3 meters.



Nipple profile

ErgoQIC 10AC

ATLAS COPCO GLOBAL STANDARD

The ErgoQIC 10AC is a full flow quick coupling with no air restriction inside the coupling suitable for assembly tools, drills and small grinders. Upgrading any air system with ErgoQIC 10AC will give the benefit of productivity and energy efficiency.

- Full flow coupling.
- Ergonomic design, small size and low weight.
- Strong and durable.
- Safety feature according to EN 983 / ISO 4414.
- Main market: Nordic, Benelux and Italy.

Technical Data

Max flow capacity	26 l/s (0.5 bar ΔP)
Economical air flow	17 l/s (0.2 bar ΔP)
Max working pressure	16 bar
Temperature range	-10°C to +70°C



Nipple profile

ErgoQIC 15AC

ATLAS COPCO GLOBAL STANDARD



The ErgoQIC 15AC is a full flow quick coupling with no air restriction inside the coupling suitable for assembly tools, drills and small grinders. Upgrading any air system with ErgoQIC 15AC will give the benefit of productivity and energy efficiency.

- Full flow coupling.
- Ergonomic design, small size and low weight.
- Strong and durable.
- Safety feature according to EN 983 / ISO 4414.
- Main market: Nordic, Benelux and Italy.

Technical Data

Max flow capacity	72 l/s (0.5 bar ΔP)
Economical air flow	48 l/s (0.2 bar ΔP)
Max working pressure	16 bar
Temperature range	-10°C to +80°C

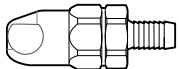
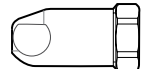
ERGOQIC 10AC, 17 L/S (recommended air flow at 6.3 bar pressure)

Connection type	Coupling ErgoQIC 10AC	Ordering No.	Size		Connection type	Coupling ErgoQIC 10AC	Ordering No.	Size	
			mm	in				mm	in
H – Hose 	H10	8202 1109 02	10	3/8	F-Female 	F08	8202 1109 09	1/4 BSP	
	H13	8202 1109 03	12.5	1/2		F10	8202 1109 10	3/8 BSP	
						F15	8202 1109 11	1/2 BSP	
M – Male thread 	M08	8202 1109 05	1/4 BSP						
	M10	8202 1109 06	3/8 BSP						
	M15	8202 1109 07	1/2 BSP						

NIP 10, 17 L/S (recommended air flow at 6.3 bar pressure) FOR ERGOQIC 10AC

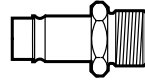
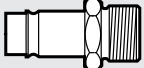
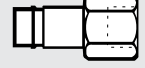
Connection type	Nipple NIP 10	Ordering No.	Size		Connection type	Nipple NIP 10	Ordering No.	Size	
			mm	in				mm	in
H – Hose 	H06	8202 1202 11	6.3	1/4	MT – Male taper thread 	MT08	8202 1202 60	1/4 BSPT	
	H08	8202 1202 94	8	5/16		MT10	8202 1202 78	3/8 BSPT	
	H10	8202 1202 29	10	3/8		MT15	8202 1203 02	1/2 BSPT	
	H13	8202 1202 34	12.5	1/2					
M – Male thread 	M06	8202 1202 37	1/8 BSP		F – Female 	F08	8202 1202 86	1/4 BSP	
	M08	8202 1202 45	1/4 BSP			F10	8202 1202 87	3/8 BSP	
	M10	8202 1202 52	3/8 BSP						

ERGOQIC 15AC, 48 L/S (recommended air flow at 6.3 bar pressure)

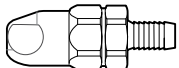
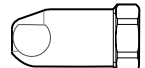
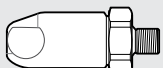
Connection type	Coupling ErgoQIC 15AC	Ordering No.	Size		Connection type	Coupling ErgoQIC 15AC	Ordering No.	Size	
			mm	in				mm	in
H – Hose 	H10	8202 1350 89	10	3/8	F-Female 	F15	8202 1350 88	1/2 BSP	
	H13	8202 1350 90	12.5	1/2					
	H16	8202 1350 91	16	5/8					
M – Male thread 	M08	8202 1350 85	1/4 BSP						
	M10	8202 1350 86	3/8 BSP						
	M15	8202 1350 87	1/2 BSP						

NIP 15, 52 L/S (recommended air flow at 6.3 bar pressure) FOR ERGOQIC 15AC

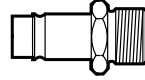
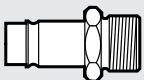
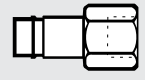
Connection type	Nipple NIP 15	Ordering No.	Size		Connection type	Nipple NIP 15	Ordering No.	Size	
			mm	in				mm	in
H – Hose 	H08	8202 1252 28	8	5/8	MT – Male taper thread 	MT08	8202 1251 60	1/4 BSPT	
	H10	8202 1251 11	10	1/4		MT10	8202 1251 78	3/8 BSPT	
	H13	8202 1251 29	12.5	3/8		MT15	8202 1251 86	1/2 BSPT	
	H16	8202 1251 37	16	1/2					
M – Male thread 	M10	8202 1251 45	3/8 BSP		F – Female 	F08	8202 1251 94	1/4 BSP	
	M15	8202 1251 52	1/2 BSP			F10	8202 1252 02	3/8 BSP	
						F15	8202 1252 10	1/2 BSP	



Nipple profile

ErgoQIC 08E

EURO STANDARD 7.6 (7.4)

The ErgoQIC 08E is a full flow quick coupling with no air restriction inside the coupling. It is suitable for assembly tools, drills and small grinders. Upgrading any air system using Eurostandard nipples with ErgoQIC 08E couplings will give the benefits of productivity and energy efficiency.

- Full flow coupling.
- Ergonomic design, small size and low weight.
- Strong and durable.
- Safety feature according to EN 983 / ISO 4414.
- Protective rubber cover available.
- Main market: Europe.

Technical Data

Max flow capacity	38 l/s (0.5 bar ΔP)
Economical air flow	24 l/s (0.2 bar ΔP)
Max working pressure	16 bar
Temperature range	-10°C to +70°C



Nipple profile

Atlas Copco SmartQIC 08E

EURO STANDARD 7.6 (7.4)

Safety coupling with venting connection, high flow and low pressure drop. Common standard used in EU-markets for many types of assembly and material removal tools.



- High reliability with low pressure drop.
- Safety function with vented connection.
- High durability and easy handling.
- High air flow and increased productivity.
- Minimizes hose whip and injuries to operator.
- Long life time.
- Safety feature according to ISO-standard 4414 and EN 983.
- Complies with OSHA 1910.95.
- Main market: Europe.

Technical Data

Max flow capacity	38 l/s (0.5 bar ΔP)
Economical air flow	35 l/s (0.2 bar ΔP)
Max working pressure	16 bar
Temperature range	-20°C to +100°C

Euro standard 7.6 (7.4) 08E

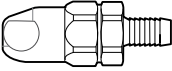
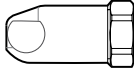
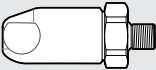
ErgoQIC 08E and ErgoNIP 08E, 24 l/s (recommended air flow at 6.3 bar pressure)

Connection type	Coupling ErgoQIC 08E	Ordering No.	Size		Connection type	Coupling ErgoQIC 08E	Ordering No.	Size	
			mm	in				mm	in
	H06	8202 1106 00	6.3	1/4		F08	8202 1106 07	1/4	BSP
	H08	8202 1106 01	8	5/16		F10	8202 1106 08	3/8	BSP
	H10	8202 1106 02	10	3/8		F15	8202 1106 09	1/2	BSP
	H13	8202 1106 03	12.5	1/2					
	M08	8202 1106 04	1/4 BSP			9090 1940 01			
	M10	8202 1106 05	3/8 BSP						
	M15	8202 1106 06	1/2 BSP						

SMARTQIC 08E, 35 L/S (recommended air flow at 6.3 bar pressure)

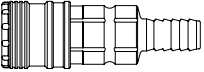
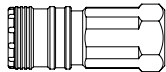
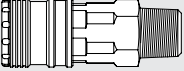
Connection type	Coupling SmartQIC-08E	Ordering No.	Size		Connection type	Coupling SmartQIC-08E	Ordering No.	Size	
			mm	in				mm	in
	H08	4221 0010 00	8	1/4		F06	4221 0010 06	1/4	BSP
	H10	4221 0010 01	10	5/16		F10	4221 0010 07	3/8	BSP
	H13	4221 0010 02	13	3/8		F15	4221 0010 08	1/2	BSP
	M06	4221 0010 03*	1/4 BSPT						
	M10	4221 0010 04*	3/8 BSPT						
	M15	4221 0010 05*	1/2 BSPT						

NIP 08E, 35 L/S (recommended air flow at 6.3 bar pressure) FOR ERGOQIC 08E AND SMARTQIC 08E

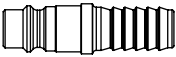
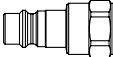
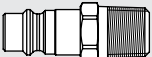
Connection type	Nipple NIP-08E	Ordering No.	Size		Connection type	Nipple NIP-08E	Ordering No.	Size	
			mm	in				mm	in
	H06	4221 0011 00	6.3	1/4		F06	4221 0011 07	1/4	BSP
	H08	4221 0011 01	8	5/16		F10	4221 0011 08	3/8	BSP
	H10	4221 0011 02	10	3/8		F15	4221 0011 09	1/2	BSP
	H13	4221 0011 03	13	5/16					
	M04	4221 0002 81*	1/8 BSPT						
	M06	4221 0011 04	1/4 BSP						
	M10	4221 0011 05	3/8 BSP						
	M15	4221 0011 06	1/2 BSP						

* Preapplied sealent.

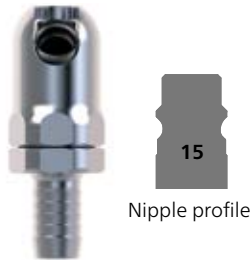

Nipple profile

ErgoQIC 15E

EURO STANDARD 10.4

The ErgoQIC 15E is a full flow coupling with no air restriction inside the coupling suitable for large air consuming assembly tools, drills and grinders.

Upgrading any air system with ErgoQIC 15E will give the benefit of productivity and energy efficiency.

- Extreme full flow coupling.
- Strong and durable.
- Minimized connection force.
- Safety feature according to EN 983 / ISO 4414.
- Main market: Europe.

Technical Data

Max flow capacity	76 l/s (0.5 bar ΔP)
Economical air flow	49 l/s (0.2 bar ΔP)
Max working pressure	16 bar
Temperature range	-20°C to +80°C

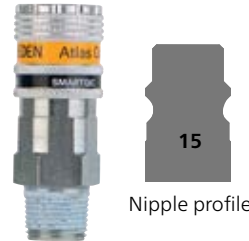

Nipple profile

Atlas Copco SmartQIC 15E

EURO STANDARD 10.4

Safety coupling with venting connection, high flow and low pressure drop. Common standard used in EU-markets for many types of assembly and material removal tools.

- High reliability with low pressure drop.
- Safety function with vented connection.
- High durability and easy handling.
- High air flow and increased productivity.
- Minimizes hose whip and injuries to operator.
- Long life time.
- Safety feature according to ISO-standard 4414 and EN 983.
- Complies with OSHA 1910.95.
- Main market: Europe.

Technical Data

Max flow capacity	68 l/s (0.5 bar ΔP)
Economical air flow	63 l/s (0.2 bar ΔP)
Max working pressure	16 bar
Temperature range	-20°C to +100°C

Euro standard 10.4 and 15 mm (15E)

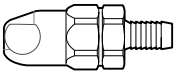
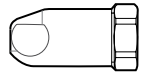
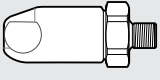

ERGOQIC 15E, 49 L/S (recommended air flow at 6.3 bar pressure)

Connection type	Coupling ErgoQIC 15E	Ordering No.	Size		Connection type	Coupling ErgoQIC 15E	Ordering No.	Size	
			mm	in				mm	in
	H10	8202 1106 50	10	3/8		F10	8202 1106 70	3/8	BSP
	H13	8202 1106 51	12.5	1/2		F15	8202 1106 71	1/2	BSP
	H16	8202 1106 52	10	3/8					
	H20	8202 1106 53	19	3/4					
	M10	8202 1106 60	3/8 BSP						
	M15	8202 1106 61	1/2 BSP						
	M20	8202 1106 62	3/4 BSP						
	M25	8202 1106 63	1 BSP						

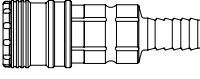
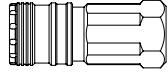
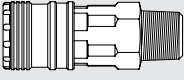
SMARTQIC 15E, 63 L/S (recommended air flow at 6.3 bar pressure)

Connection type	Coupling SmartQIC 15E	Ordering No.	Size		Connection type	Coupling SmartQIC 15E	Ordering No.	Size	
			mm	in				mm	in
	H10	4221 0020 00	10	3/8		F10	4221 0020 07	3/8	BSP
	H13	4221 0020 01	13	1/2		F15	4221 0020 08	1/2	BSP
	H16	4221 0020 02	16	5/8		F20	4221 0020 09	3/4	BSP
	H20	4221 0020 03	19	3/4					
	M10	4221 0020 04	3/8 BSPT						
	M15	4221 0020 05	1/2 BSPT						
	M20	4221 0020 06	3/4 BSPT						

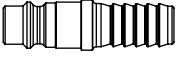
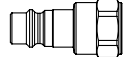
NIP-15E, EU 10.4, 63 L/S (recommended air flow at 6.3 bar pressure) FOR ERGOQIC 15E AND SMARTQIC 15E

Connection type	Nipple NIP-15E	Ordering No.	Size		Connection type	Nipple NIP-15E	Ordering No.	Size	
			mm	in				mm	in
	H10	4221 0021 00	10	3/8		F10	4221 0021 07	3/8	BSP
	H13	4221 0021 01	13	1/2		F15	4221 0021 08	1/2	BSP
	H16	4221 0021 02	16	5/8		F20	4221 0021 09	3/4	BSP
	H20	4221 0021 03	19	3/4					
	M10	4221 0021 04	3/8 BSPT						
	M15	4221 0021 05	1/2 BSPT						
	M20	4221 0021 06	3/4 BSPT						

NOTE: T at the end stands for tapered thread e.g. BSPT.



Nipple profile

ErgoQIC 08US

ISO 6150-B / US STANDARD

The ErgoQIC 08US is a full flow quick coupling with no air restriction inside the coupling suitable for assembly tools, drills and small grinders. Upgrading any air system with ErgoQIC 08US will give the benefit of productivity and energy efficiency.

- Full flow coupling.
- Ergonomic design, small size and low weight.
- Strong and durable.
- Safety feature according to EN 983 / ISO 4414.
- Main market: North America, France, Norway and Spain.

Technical Data

Max flow capacity	17 l/s (0.5 bar ΔP)
Economical air flow	11 l/s (0.2 bar ΔP)
Max working pressure	16 bar
Temperature range	-20°C to +80°C



Nipple profile

Atlas Copco SmartQIC 08US

ISO 6150-B / US STANDARD

Safety coupling with venting connection, high flow and low pressure drop.

- High reliability with low pressure drop.
- Safety function with vented connection.
- High durability and easy handling.
- High air flow and increased productivity.
- Minimizes hose whip and injuries to operator.
- Long life time.
- Safety feature according to ISO-standard 4414 and EN 983.
- Main market: Benelux, France, Norway and North America.

Technical Data

Max flow capacity	16 l/s (0.5 bar ΔP)
Economical air flow	15 l/s (0.2 bar ΔP)
Max working pressure	16 bar
Temperature range	-20°C to +100°C

ISO 6150-B / US Standard 5.3 mm (1/4") 08US

ERGOQIC 08US, 11 L/S (recommended air flow at 6.3 bar pressure)

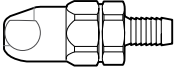
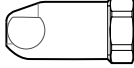
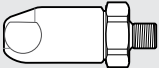
Connection type	Coupling ErgoQIC 08US	Ordering No.	Size		Connection type	Coupling ErgoQIC 08US	Ordering No.	Size	
			mm	in				mm	in
	H06	8202 1103 00	6.3	1/4		F08	8202 1103 11	1/4	BSP
	H08	8202 1103 01	8	5/16		F10	8202 1103 13	3/8	BSP
	H10	8202 1103 02	10	3/8					
	M08	8202 1103 05		1/4	BSP				
	M10	8202 1103 07		3/8	BSP				
	M15	8202 1103 09		1/2	BSP				

SMARTQIC 08US, 15 L/S (recommended air flow at 6.3 bar pressure)

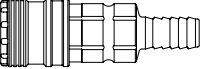
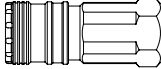
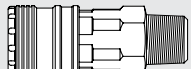
Connection type	Coupling SmartQIC 08US	Ordering No.	Size		Connection type	Coupling SmartQIC 08US	Ordering No.	Size	
			mm	in				mm	in
	H06	4221 0030 00	6.3	1/4		F08	4221 0030 07	1/4	BSP
	H08	4221 0030 01	8	5/16		F10	4221 0030 08	3/8	BSP
	H10	4221 0030 02	10	3/8		F08	4221 0030 09	1/4	NPT
	M08	4221 0030 03		3/8	BSPT	F10	4221 0030 10	3/8	NPT
	M10	4221 0030 04		1/2	BSPT				
	M08	4221 0030 05		3/8	NPT				
	M10	4221 0030 0		1/2	NPT				

NIP 08US, 11 L/S (recommended air flow at 6.3 bar pressure) FOR ERGOQIC 08US AND SMARTQIC 08US

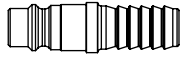
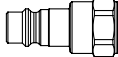
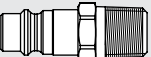
Connection type	Nipple NIP 08US	Ordering No.	Size		Connection type	Nipple NIP 08US	Ordering No.	Size	
			mm	in				mm	in
	H06	4221 0031 00	6.3	1/4		F06	4221 0031 07	1/4	BSP
	H08	4221 0031 01	8	5/16		F10	4221 0031 08	3/8	BSP
	H10	4221 0031 02	10	3/8		F06	4221 0031 09	1/4	NPT
	M04	4221 0002 82*		1/8	BSPT	F10	4221 0031 10	3/8	NPT
	M08	4221 0031 03*		1/4	BSPT				
	M10	4221 0031 04*		3/8	BSPT				
	M08	4221 0031 05*		1/4	NPT				
	M10	4221 0031 06*		3/8	NPT				

* Preapplied sealent.

NOTE: T at the end stands for tapered thread e.g. BSPT.

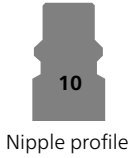

Nipple profile

ErgoQIC 10US

ISO 6150-B / US STANDARD

The ErgoQIC 10US is a full flow quick coupling with no air restriction inside the coupling suitable for assembly tools, drills and small grinders. Upgrading any air system with ErgoQIC 10US couplings will give the benefit of productivity and energy efficiency. It is interchangeable with US 3/8" standard nipples.

- Full flow coupling.
- Ergonomic design, small size and low weight.
- Strong and durable.
- Safety feature according to EN 983 / ISO 4414.
- Main market: North America, France, Norway and Spain.

Technical Data

Max flow capacity	43 l/s (0.5 bar ΔP)
Economical air flow	27 l/s (0.2 bar ΔP)
Max working pressure	16 bar
Temperature range	-20°C to +80°C

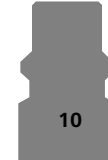

Nipple profile

Atlas Copco SmartQIC 10US

ISO 6150-B / US STANDARD

Safety coupling with venting connection, high flow and low pressure drop.

- High reliability with low pressure drop.
- Safety function with vented connection.
- High durability and easy handling.
- High air flow and increased productivity.
- Minimizes hose whip and injuries to operator.
- Long life time.
- Safety feature according to ISO-standard 4414 and EN 983.
- Main market: Benelux, France, Norway and North America.

Technical Data

Max flow capacity	43 l/s (0.5 bar ΔP)
Economical air flow	39 l/s (0.2 bar ΔP)
Max working pressure	16 bar
Temperature range	-20°C to +100°C

ISO 6150-B / US Standard 8.2 mm (3/8") 10US

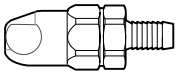
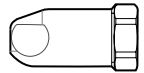
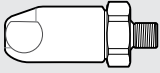

ERGOQIC 10US, 27 L/S (recommended air flow at 6.3 bar pressure)

Connection type	Coupling ErgoQIC 10US	Ordering No.	Size		Connection type	Coupling ErgoQIC 10US	Ordering No.	Size	
			mm	in				mm	in
H – Hose 	H10	8202 1107 02	10	3/8	F-Female 	F08	8202 1107 13	1/4	BSP
	H13	8202 1107 03	12.5	1/2		F10	8202 1107 15	3/8	BSP
	H20	8202 1107 05	19	3/4		F15	8202 1107 17	1/2	BSP
M – Male thread 	M08	8202 1107 07	1/4 BSP						
	M10	8202 1107 09	3/8 BSP						
	M15	8202 1107 11	1/2 BSP						

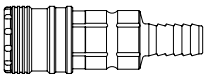
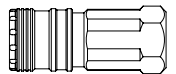
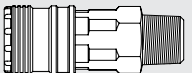
SMARTQIC 10US, 39 L/S (recommended air flow at 6.3 bar pressure)

Connection type	Coupling SmartQIC 10US	Ordering No.	Size		Connection type	Coupling SmartQIC 10US	Ordering No.	Size	
			mm	in				mm	in
H – Hose 	H10	4221 0050 00	10	3/8	F-Female 	F10	4221 0050 06	3/8	BSP
	H13	4221 0050 01	13	1/2		F15	4221 0050 07	1/2	BSP
							F10	4221 0050 08	3/8
M – Male 	M10	4221 0050 02	3/8 BSPT						
	M15	4221 0050 03	1/2 BSPT						
	M10	4221 0050 04	3/8 NPT						
	M15	4221 0050 05	1/2 NPT						

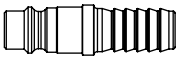
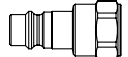
NIP-10US, 39 L/S (recommended air flow at 6.3 bar pressure) FOR ERGOQIC 10US AND SMARTQIC 10US

Connection type	Nipple NIP 10US	Ordering No.	Size		Connection type	Nipple NIP 10US	Ordering No.	Size	
			mm	in				mm	in
H – Hose 	H08	4221 0051 00	8	5/16	F-Female 	F06	4221 0051 09	1/4	BSP
	H10	4221 0051 01	10	3/8		F10	4221 0051 10	3/8	BSP
	H13	4221 0051 02	13	1/2		F15	4221 0051 11	1/2	BSP
M – Male thread 	M06	4221 0051 03	1/4 BSPT						
	M10	4221 0051 04	3/8 BSPT						
	M15	4221 0051 05	1/2 BSP						
	M06	4221 0051 06	1/4 NPT						
	M10	4221 0051 07	3/8 NPT						
	M15	4221 0051 08	1/2 NPT						

NOTE: T at the end stands for tapered thread e.g. BSPT.



Nipple profile

ErgoQIC 15US

ISO 6150-B / US STANDARD

The ErgoQIC 15US is a full flow coupling with no air restriction inside the coupling suitable for large air consuming assembly tools, drills and grinders. Upgrading any air system with ErgoQIC 15US will give the benefit of productivity and energy efficiency. It is interchangeable with US 1/2" standard nipples.

- Extreme full flow coupling.
- Strong and durable.
- Minimized connection force.
- Safety feature according to EN 983 / ISO 4414.
- Main market: North America, France, Norway and Spain.

Technical Data

Max flow capacity	77 l/s (0.5 bar ΔP)
Economical air flow	52 l/s (0.2 bar ΔP)
Max working pressure	16 bar
Temperature range	-20°C to +80°C

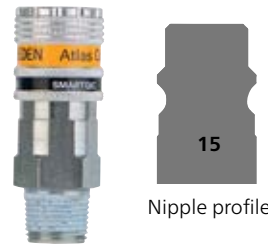

Nipple profile

Atlas Copco SmartQIC 15US

ISO 6150-B / US STANDARD

Safety coupling with venting connection, high flow and low pressure drop.



- High reliability with low pressure drop.
- Safety function with vented connection.
- High durability and easy handling.
- High air flow and increased productivity.
- Minimizes hose whip and injuries to operator.
- Long life time.
- Safety feature according to ISO-standard 4414 and EN 983.
- Main market: North America, France, Norway and Spain.

Technical Data

Max flow capacity	69 l/s (0.5 bar ΔP)
Economical air flow	64 l/s (0.2 bar ΔP)
Max working pressure	16 bar
Temperature range	-20°C to +100°C

ISO 6150-B / US standard 11 mm (1/2") 15US

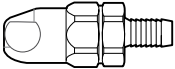
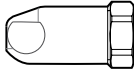
ERGOQIC 15US, 52 L/S (recommended air flow at 6.3 bar pressure)

Connection type	Coupling ErgoQIC 15US	Ordering No.	Size		Connection type	Coupling ErgoQIC 15US	Ordering No.	Size	
			mm	in				mm	in
H – Hose 	H10	8202 1108 02	10	3/8	F-Female 	F10	8202 1108 15	3/8	BSP
	H13	8202 1108 03	12.5	1/2		F15	8202 1108 17	1/2	BSP
	H16	8202 1108 04	16	5/8					
	H20	8202 1108 0	19	3/4					
M – Male thread 	M10	8202 1108 09	3/8 BSP						
	M15	8202 1108 11	1/2 BSP						

SMARTQIC 15US, 64 L/S (recommended air flow at 6.3 bar pressure)

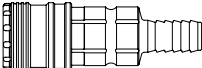
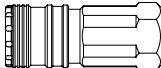
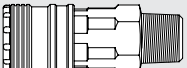
Connection type	Coupling SmartQIC 15US	Ordering No.	Size		Connection type	Coupling SmartQIC 15US	Ordering No.	Size	
			mm	in				mm	in
H – Hose 	H13	4221 0040 00	13	1/2	F-Female 	F10	4221 0040 06	3/8	NPT
	H20	4221 0040 02	19	3/4		F15	4221 0040 07	1/2	NPT
							F20	4221 0040 08	3/4
M – Male 	M10	4221 0040 03	3/8 NPT						
	M15	4221 0040 04	1/2 NPT						
	M20	4221 0040 05	3/4 NPT						

NIP 15US, 64 L/S (recommended air flow at 6.3 bar pressure) FOR ERGOQIC 15US AND SMARTQIC 15US

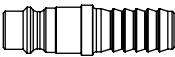
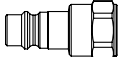
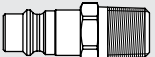
Connection type	Nipple NIP 15US	Ordering No.	Size		Connection type	Nipple NIP 15US	Ordering No.	Size	
			mm	in				mm	in
H – Hose 	H10	4221 0041 00	10	3/8	F-Female 	F10	4221 0041 07	3/8	NPT
	H13	4221 0041 01	13	1/2		F15	4221 0041 08	1/2	NPT
	H20	4221 0041 03	19	3/4		F20	4221 0041 09	3/4	NPT
M – Male thread 	M10	4221 0041 04	3/8 NPT						
	M15	4221 0041 05	1/2 NPT						
	M20	4221 0041 06	3/4 NPT						

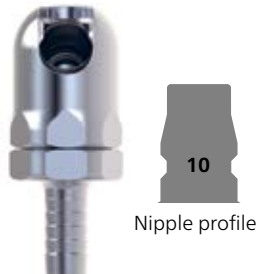

Nipple profile

ErgoQIC 10A

ASIA STANDARD 7.5 MM

The ErgoQIC 10 ASIA is a full flow coupling with no air restriction inside the coupling. It is suitable for assembly tools, drills and grinders. Upgrading any air system with ErgoQIC 10 ASIA will give the benefits of productivity and energy efficiency.

- Extreme full flow coupling.
- Strong and durable.
- Minimized connection force.
- Safety feature according to EN 983 / ISO 4414.
- Main market: Asia, Australia, Italy and South America.

Technical Data

Max flow capacity	35 l/s (0.5 bar Δ P)
Economical air flow	22 l/s (0.2 bar Δ P)
Max working pressure	16 bar
Temperature range	-20°C to +70°C



Nipple profile

Atlas Copco SmartQIC 10A

ASIA STANDARD 7.5 MM

Safety coupling with venting connection, high flow and low pressure drop.



- High reliability with low pressure drop.
- Safety function with vented connection.
- High durability and easy handling.
- High air flow and increased productivity.
- Minimizes hose whip and injuries to operator.
- Long life time.
- Safety feature according to ISO-standard 4414 and EN 983.
- Main market: Asia, Australia, Italy and South America.

Technical Data

Max flow capacity	33 l/s (0.5 bar Δ P)
Economical air flow	32 l/s (0.2 bar Δ P)
Max working pressure	16 bar
Temperature range	-20°C to +100°C

ASIA Standard 7.5 mm A

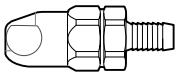
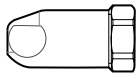
ERGOQIC 10A, 22 L/S (recommended air flow at 6.3 bar pressure)

Connection type	Coupling ErgoQIC 10A	Ordering No.	Size		Connection type	Coupling ErgoQIC 10A	Ordering No.	Size	
			mm	in				mm	in
	H06	8202 1104 00	6.3	1/4	FT – Female taper thread 	FT08	8202 1104 09	1/4	BSPT
	H08	8202 1104 01	8	5/16		FT10	8202 1104 10	3/8	BSPT
	H10	8202 1104 02	10	3/8		FT15	8202 1104 11	1/2	BSPT
	H13	8202 1104 03	12.5	1/2					
MT – Male taper thread 	MT08	8202 1104 05		1/4	BSPT				
	MT10	8202 1104 06		3/8	BSPT				
	MT15	8202 1104 07		1/2	BSPT				

SMARTQIC 10A, 32 L/S (recommended air flow at 6.3 bar pressure)

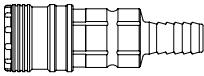
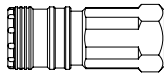
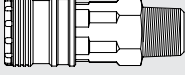
Connection type	Coupling SmartQIC 10A	Ordering No.	Size		Connection type	Coupling SmartQIC 10A	Ordering No.	Size	
			mm	in				mm	in
	H06	4221 0060 00	6.3	1/4	F-Female thread 	F06	4221 0060 06	1/4	BSP
	H08	4221 0060 01	7	9/32		F10	4221 0060 07	3/8	BSP
	H10	4221 0060 02	10	3/8		F15	4221 0060 08	1/2	BSP
M – Male thread 	M06	4221 0060 03		1/4	BSP				
	M10	4221 0060 04		3/8	BSP				
	M15	4221 0060 05		1/2	BSP				

NIP 10A, 22 L/S (recommended air flow at 6.3 bar pressure) FOR ERGOQIC 10A AND SMARTQIC 10A

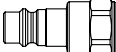
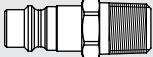
Connection type	Nipple NIP 10A	Ordering No.	Size		Connection type	Nipple NIP 10A	Ordering No.	Size	
			mm	in				mm	in
	H06	4221 0061 00	6.3	1/4	F-Female 	F06	4221 0061 07	1/4	BSPT
	H08	4221 0061 01	7	9/32		F10	4221 0061 08	3/8	BSPT
	H10	4221 0061 02	10	3/8		F15	4221 0061 09	1/2	BSPT
	H13	4221 0061 03	12.5	1/2					
M – Male thread 	M04	4221 0002 83		1/8	BSPT				
	M06	4221 0061 04		1/4	BSPT				
	M10	4221 0061 05		3/8	BSPT				
	M15	4221 0061 06		1/2	BSPT				

Claw

couplings



CLAW couplings are made from dropforged, hardened steel which can withstand rough treatment and ensures a long life even under difficult conditions. The coupling head is the same for all sizes, which can therefore be freely combined. The recommended maximum working pressure is 10 bar.

- Large bore – machined surfaces give low air resistance and minimum pressure drop.
- Robust claws – will withstand rough handling without deformation.
- Locking lugs – precision-made to provide a reliable lock.
- Special rubber packings – resistant to oil and temperature changes. Max. temperature 80°C (176°F).
- Packing seats – lathe-turned grooves ensure a leak-proof seal.
- Couplings are zinc-plated and thus effectively treated against corrosion.
- Available with extra protective cover.

Connection type	Coupling CLAW	Ordering No.	Size		Bore B, mm	
			mm	in		
H – Hose		H06	9000 0308 00	6.3	1/4	5.0
		H10	9000 0309 00	10	3/8	8.0
		H13	9000 0310 00	12.5	1/2	10.5
		H16	9000 0311 00	16	5/8	13.5
		H20	9000 0312 00	19	3/4	17.0
		H25	9000 0313 00	25	1	22.0
		LNH – Lock nut, Hose		LNH10	9000 0260 00	10
LNH13	9000 0261 00			12.5	1/2	10.5
LNH16	9000 0262 00			16	5/8	13.5
LNH20	9000 0263 00			19	3/4	17.2
LNH25	9000 0264 00			25	1	22.0
M – Male thread				M10	9000 0300 00	3/8 BSP
		M15	9000 0301 00	1/2 BSP		14.8
		M20	9000 0302 00	3/4 BSP		19.0
		M25	9000 0303 00	1 BSP		25.5
F – Female thread		F10	9000 0304 00	3/8 BSP		15.0
		F15	9000 0305 00	1/2 BSP		18.6
		F20	9000 0306 00	3/4 BSP		24.0
		F25	9000 0307 00	1 BSP		25.0
Protection cover for CLAW couplings			9000 0314 00			
Extra packing for CLAW couplings		For type H, M and F	9000 0000 00 (+80oC), 9000 0000 01 (+200oC) ^a			
		For LNH10, -13 and -16	9000 0015 00			
		For LNH20 and -25	9000 0268 00 (+80oC), 9000 0319 00 (+200oC) ^a			

^a Viton-green.

Ball

Valves



BAL



BAL-1A

The Atlas Copco **valves BAL and BAL-1A** are both suitable for air, water and many other liquids and gases due to the choice of material.

- Silicone-free grease – Both are lubricated with silicone-free grease which is important when spray-painting.
- Maximum through flow – Full bore valve to DIN standards.
- Housing and ball made of chrome-plated hot-stamped brass MS 58.
- Handle of enamelled aluminum.

BAL – with nitrile rubber seals

BAL valves can be used in all settings between fully open and fully closed. The balls and the seals can be replaced without the body being removed from the piping.

BAL-1A – with teflon seals

Intended for operating either fully open or fully closed.

Technical Data

BAL

Maximum working pressure: 16 bar.
Working temperature range: -20°C to +90°C.

BAL-1A

Maximum working pressure: 16 bar
(BAL-1A 40 and 50: max. 16 bar up to +100°C).
Working temperature range: -30°C to +200°C. (BAL-1A 40 and 50: at +200°C max working pressure is reduced to 8 bar).

Model	Connection thread in BSP	Bore D mm	L mm	H mm	I mm	Ordering No.
BAL 08	1/4	9.5	50	41	-	8202 0301 05
BAL 10	3/8	9.5	50	41	-	8202 0302 04
BAL 15	1/2	12.5	60	43	-	8202 0303 03
BAL 20	3/4	19	75	55	-	8202 0304 02
BAL 25	1	24.5	90	64	-	8202 0305 01
BAL-1A 08	1/4	8	43	44	73	8202 0306 03
BAL-1A 10	3/8	10	50	47	73	8202 0306 11
BAL-1A 15	1/2	15	61	53	94	8202 0306 29
BAL-1A 20	3/4	20	70	57	94	8202 0306 37
BAL-1A 25	1	25	83	67.5	122	8202 0306 45
BAL-1A 32	1 1/4	32	100	83	150	8202 0306 52
BAL-1A 40	1 1/2	38	107	87	150	8202 0306 60
BAL-1A 50	2	50	129	103	193	8202 0306 78

Dimensions

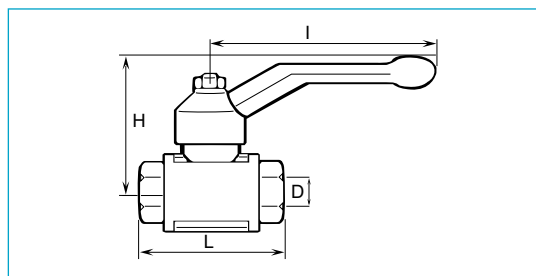
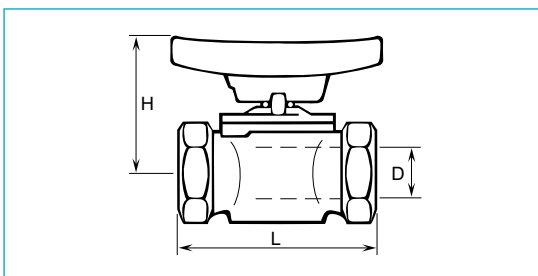

Swivel

connectors



The MultiFlex swivel is an ingenious multi-directional connector. Connect your tool and the hose will stay in the ideal position however much you and the tool move around. The MultiFlex bends and rotates 360° in all directions while the hose stays straight. It takes the effort out of working in those cramped spaces. What's more, the hose feels almost weightless and it reduces hose wear. It's the magic of MultiFlex – a marriage of ergonomic thinking and ingenious design.

- Ergonomic.
- Reduces hose wear.
- High flow capacity.
- Minimum pressure drop.
- Strong and durable.
- Available with rubber (EPDM) protective cover.
- Fits most pneumatic tools.

Model	Max rec. air flow		Thread		Weight g	Length mm	Dia mm	Ordering No.
	l/s	CFM	Inlet female In	Outlet male In				
Standard								
MultiFlex 1/8" BSP	12	25	1/8	1/8	73	66.2	24	8202 1350 18
MultiFlex 1/4" BSP	12	25	1/4	1/4	73	66.2	24	8202 1350 20
MultiFlex 3/8" BSP	32	68	3/8	3/8	130	80.6	29.5	8202 1350 22
MultiFlex 1/2" BSP	32	68	1/2	1/2	125	80.6	29.5	8202 1350 24
Protective rubber cover								
MultiFlex 1/8" BSP	12	25	1/8	1/8	76	66.2	27	8202 1350 40
MultiFlex 1/4" BSP	12	25	1/4	1/4	76	66.2	27	8202 1350 41
MultiFlex 3/8" BSP	32	68	3/8	3/8	130	80.6	29.5	8202 1350 42
High air flow								
MultiFlex 1/2" BSP	54	114	1/2	1/2	326	98.3	39	8202 1350 60
Female to male thread								
FBSP 1/4" - MBSP 1/8"	12	25	1/4	1/8	73	66.2	24	8202 1350 67

The pressure drop will be 0.2 bar at an inlet pressure of 6 bar.

Fittings



Simple pressure clamps for PVC and CABLAIR HOSES

For CABLAIR	For PVC	One-lugged steel clamp mm	Ordering No.
-	-	5.2- 6.2	0347 0122 18
-	03	5.9- 7.0	0347 0122 19
-	03	7.0- 8.5	0347 0122 05
06	05	8.5-10.0	0347 0122 06
08	06	9.8-11.8	0347 0122 07
-	08	11.3-13.3	0347 0122 08
10	10	12.8-14.8	0347 0122 09
13	10	14.6-16.8	0347 0122 10
-	18	16.5-18.8	0347 0122 11
-	13	18.0-20.3	0347 0122 12
16	16	20.2-22.8	0347 0122 13
-	-	22.0-24.8	0347 0122 14
20	25	23.3-26.3	0347 0122 15
-	-	26.5-30.0	0347 0122 16
25	25	29.8-33.1	0347 0122 22



Hose connection Male thread – hose nipple

Thread in	Hose size		Ordering No.
	mm	in	
1/8 BSP	3.2	1/8	9000 0523 00
1/8 BSPT	5	3/16	4010 0031 00
1/8 BSPT	6.3	1/4	9000 0240 00
1/4 BSP	3.2	1/8	9000 0524 00
1/4 BSPT	6.3	1/4	9000 0241 00
1/4 BSPT	8	5/16	9090 1715 00
1/4 BSPT	10	3/8	9000 0247 00
3/8 BSPT	10	3/8	9000 0242 00
3/8 BSPT	12.5	1/2	9000 0248 00
1/2 BSPT	12.5	1/2	9000 0243 00
1/2 BSPT	16	5/8	9000 0244 00
1/2 BSP	20	3/4	4150 0429 00
3/4 BSPT	20	3/4	9000 0245 00
1 BSPT	25	1	9000 0246 00



Medium pressure clamps

For CABLAIR	For PVC, POLUR	For TURBO, RUBAIR	RUBBER	Medium clamp worm drive, mm	Ordering No.
08, 10	05, 06, 08, 10	-	06	8.0-16.0	4221 0003 68
13	13	-	10	13.0-20.0	0347 6104 00
16	16	13, 16	13	15.0-24.0	0347 6105 00
19	20	20	16	20.0-32.0	4221 0003 96
25	25	25	20	26.0-38.0	0347 6109 00
-	-	-	25	32.0-44.0	0347 6111 00
-	-	-	-	38.0-50.0	0347 6112 00



Gaskets

For couplings with male parallel thread	Fiber gasket between material and nipple Ordering No.
1/8 BSP	0657 5742 00
1/4 BSP	0657 5764 00
3/8 BSP	0657 5785 00
1/2 BSP	0653 0500 01
3/4 BSP	0657 5823 00
1 BSP	0657 5830 00



Heavy-duty pressure clamps

For TURBO, RUBAIR	RUBBER	Medium clamp worm drive, mm	Ordering No.
16	16	22.0-25.0	9000 0194 00
20	-	25.0-28.0	9000 0195 00
25	20	29.0-32.0	9000 0196 00
-	25	34.0-38.0	9000 0197 00



Reducing nipple in brass

Female thread in	Male thread in	Ordering No.
1/4 BSP	1/8 BSP	9721 4000 94
3/8 BSP	1/4 BSP	9721 4000 92
1/2 BSP	3/8 BSP	9721 4000 93

Fittings



Bushing Male thread – female thread

Male thread in	Female thread in	Ordering No.
1/4 BSP	1/8 BSP	9090 0799 00
3/8 BSP	1/4 BSP	9090 0798 00
1/2 BSP	1/4 BSP	9090 1469 00
1/2 BSP	3/8 BSP	9090 0797 00
3/4 BSP	1/2 BSP	9090 0796 00
1 BSPT	3/4 BSP	9090 0795 00



Double connection Male taper thread – male taper thread

From thread in	To thread in	Ordering No.
1/8 BSPT	1/8 BSPT	9090 0100 00
1/8 BSPT	1/4 BSPT	9090 0110 00
1/4 BSPT	1/4 BSPT	9090 0120 00
1/4 BSPT	3/8 BSPT	9090 0130 00
3/8 BSPT	3/8 BSPT	9090 0140 00
3/8 BSPT	1/2 BSPT	9090 0150 00
1/2 BSPT	1/2 BSPT	9090 0160 00
1/2 BSPT	3/4 BSPT	9090 0170 00
3/4 BSPT	3/4 BSPT	9090 0180 00
3/4 BSPT	1 BSPT	9090 0190 00
1 BSPT	1 BSPT	9090 0200 00



Double adjustable connection Male thread – male thread

From thread in	To thread in	Ordering No.
1/2 BSP	1/2 BSP	9090 0806 00



Sealing rings for double adjustable connection

For coupling with male thread in	Spare rubber sealing ring for adjustable connections Ordering No.
1/2 BSP	9090 0884 00

Hose connection with clamp nut and spring guard

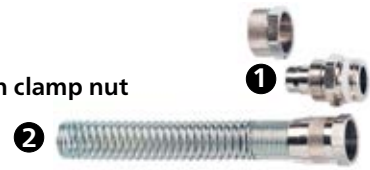

1 Clamp nut, brass

Hose diameter Outside/Inside mm	Male thread in	Ordering No.
15/12.5	1/2 BSP	9721 4000 89

Male threaded hose nipple with clamp nut should be used with female threaded quick couplings.

2 Spring guard in steel

Hose diameter Outside/Inside mm	Ordering No.
15/12	9721 4002 85

The spring guard should be used with the clamp nut above.



Manifolds 3/8 inlet on each side, 1/4 outlets for couplings

Thread		Number of outlets	Ordering No.
Inlet in	Outlet in		
3/8 BSP	1/4 BSP	4	9090 0201 00
3/8 BSP	1/4 BSP	6	9090 0201 02



Manifolds 3/8 inlet on each side, 1/4 outlet on both sides for couplings

Thread		Number of outlets	Ordering No.
Inlet in	Outlet in		
3/8 BSP	1/4 BSP	4	9090 0201 10
3/8 BSP	1/4 BSP	8	9090 0201 12
3/8 BSP	1/4 BSP	10	9090 0201 13

Y-connections
2 female outlets and 1 male inlet



Model	From thread in	To thread in	Ordering No.
F/F/M08	1/4 BSP	1/4 BSP	9090 0201 86
F/F/M10	3/8 BSP	3/8 BSP	9090 0201 87
F/F/M15	1/2 BSP	1/2 BSP	9090 0201 85

PIPE TEE



Model	Female threads in	Ordering No.
F08	1/4 BSP	9090 0201 51
F10	3/8 BSP	9090 0201 53
F15	1/2 BSP	9090 0201 50
F20	3/4 BSP	9090 0201 52
F25	1 BSP	9090 0201 54

PIPE CROSS



Model	Female threads in	Ordering No.
F08	1/4 BSP	9090 0201 21
F10	3/8 BSP	9090 0201 22
F15	1/2 BSP	9090 0201 20

BRANCH TEE
2 female outlets and 1 male inlet



Model	Female thread in	Male thread in	Ordering No.
2xF08 1xM08	1/4 BSP	1/4 BSP	9090 0201 61
2xF10 1xM10	3/8 BSP	3/8 BSP	9090 0201 63
2xF15 1xM15	1/2 BSP	1/2 BSP	9090 0201 60
2xF20 1xM20	3/4 BSP	3/4 BSP	9090 0201 62

CROSS
3 female threads and 1 male thread



Model	Female thread in	Male thread in	Ordering No.
3xF08 1xM08	1/4 BSP	1/4 BSP	9090 0201 31
3xF10 1xM10	3/8 BSP	3/8 BSP	9090 0201 32
3xF15 1xM15	1/2 BSP	1/2 BSP	9090 0201 30

RUN TEE
2 female outlets and 1 male inlet



Model	Female thread in	Male thread in	Ordering No.
F08/M08/F08	1/4 BSP	1/4 BSP	9090 0201 71
F10/M10/F10	3/8 BSP	3/8 BSP	9090 0201 72
F15/M15/F15	1/2 BSP	1/2 BSP	9090 0201 70

PIPE CROSS



Model	Female threads in	Ordering No.
F08	1/4 BSP	9090 0201 40
F10	3/8 BSP	9090 0201 43
F15	1/2 BSP	9090 0201 41
F20	3/4 BSP	9090 0201 42
F25	1 BSP	9090 0201 44

HEX HEAD PLUG



Model	Male threads in	Ordering No.
M08	1/4 BSP	9090 0201 81
M10	3/8 BSP	9090 0201 84
M15	1/2 BSP	9090 0201 80
M20	3/4 BSP	9090 0201 83
M25	1 BSP	9090 0201 82

HOSES



Pressure drop diagram for straight hoses

This diagram helps you to choose the right hose according to the air consumption of the tool and the length of the hose. The purpose of the diagram is to ensure that the pressure drop in the hoses does not exceed 0.2 bar.

PRESSURE DROP DIAGRAM FOR HOSES

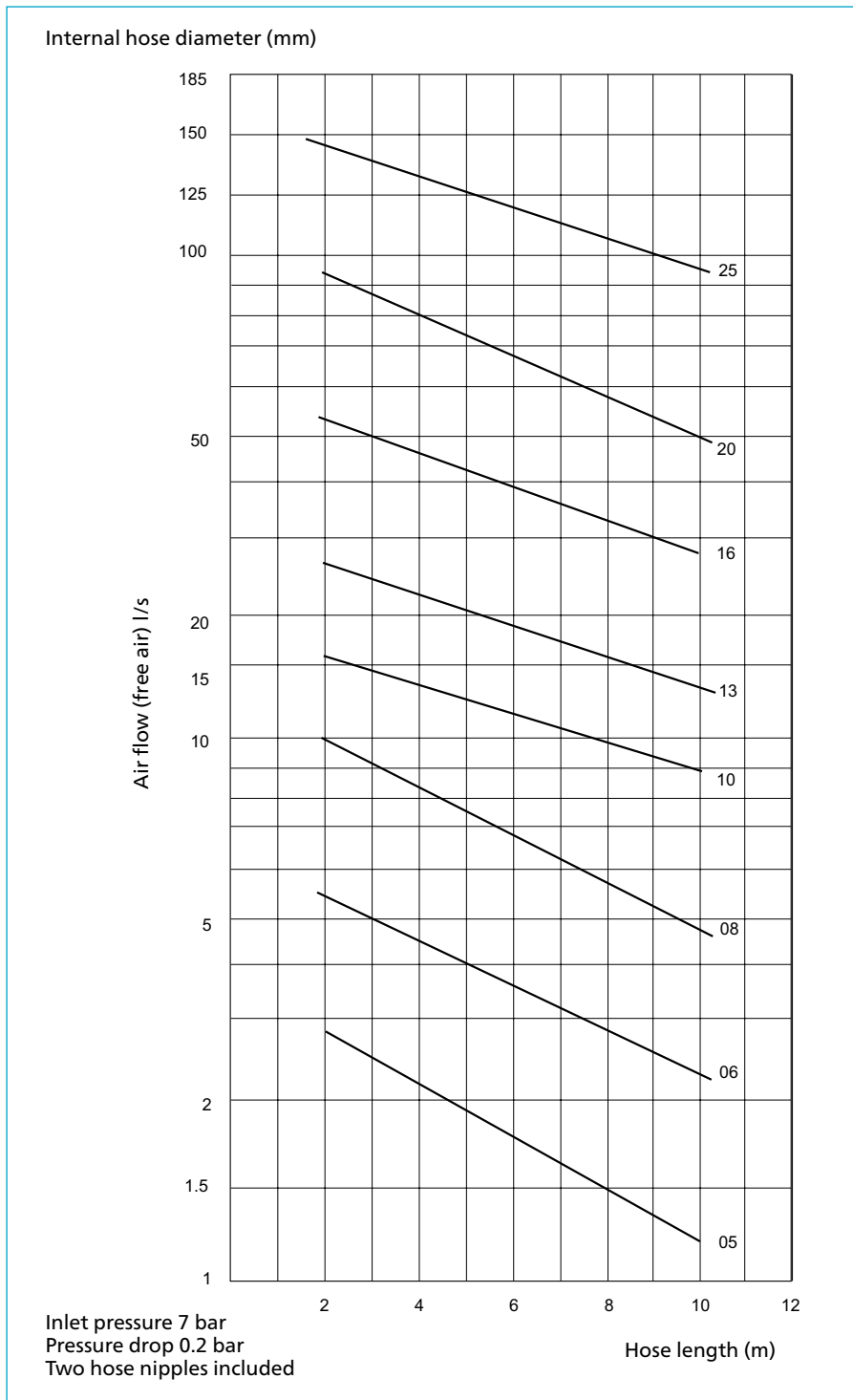

HOW TO READ THE DIAGRAM:

Look up the tools required air consumption at 6 bar. Use this value in the diagram .

What length of hose do you need?

Look at the diagram to see which hose size you need.

Decide which type of hose you need, Atlas Copco Tools has seven different hoses covering all types of needs for pneumatic hand tools.

EXAMPLE

The tool has an air consumption of 10 l/s and the application requires a hose length of 7 m. These two values have a cross point slightly under the 10 mm size hose (7 m of 10 mm hose gives a value of approximately 11 l/s).

Therefore a 10 mm hose will be suitable.

Rubber

hoses



TURBO

Super-light flexible rubber hose

The Turbo hose has been developed for both indoor and outdoor use. The hose weighs 30–40% less than conventional rubber hoses. Turbo hose is oil resistant.

- Extremely low weight.
- Soft and flexible.
- Antistatic.
- Grinding and welding spatter resistant.
- Working temperature -30°C to +70°C.

Model	Hose inside dia		Hose outside dia mm	Max working pressure ^a bar	Max rec. air flow ^b	Weight per		Ordering No.
	mm	in				20 m coil kg	30 m coil kg	
TURBO 13	13	1/2	19	20	21	3.9	–	9093 0057 91
TURBO 13	13	1/2	19	20	21	–	5.9	9093 0057 93
TURBO 16	16.8	2/3	22.8	20	43	4.8	–	9093 0057 31
TURBO 16	16.8	2/3	22.8	20	43	–	7.2	9093 0057 33
TURBO 20	21	5/6	27	20	75	5.4	–	9093 0057 61
TURBO 20	21	5/6	27	20	75	–	8.1	9093 0057 62

^a With a safety factor of 3 at 20°C.

^b The pressure drop will be 0.2 bar on a hose length of 5 m, including 2 nipples and at an inlet pressure of 7 bar.



RUBBER

Durable, reinforced, extra thick, heavy duty rubber hose

Withstands rough handling and is suitable for the most demanding industrial tasks. The inner lining is black EPDM rubber and the hose is conductive to dissipate static electricity. Reinforced with synthetic textile yarns that provide high tensile strength.

- Durable.
- Grinding and welding spatter resistant.
- Working temperature -25°C to +70°C.

Model	Hose inside dia		Hose outside dia mm	Max working pressure ^a bar	Max rec. air flow ^b	Weight per 30m coil	Ordering No.
	mm	in					
RUBBER 06	6.3	1/4	12	16	4	3.5	9093 0057 91
RUBBER 10	10	3/8	17	16	13	6.9	9093 0057 93
RUBBER 13	12.5	1/2	22	16	21	12.3	9093 0057 31
RUBBER 16	16	5/8	25	16	43	13.9	9093 0057 33
RUBBER 20	20	3/4	30	16	75	19.3	9093 0057 61
RUBBER 25	25	1	36	16	125	24.0	9093 0057 62

^a With a safety factor of 3 at 20°C.

^b The pressure drop will be 0.2 bar on a hose length of 5 m, including 2 nipples and at an inlet pressure of 7 bar.



RUBAIR

Durable reinforced heavy duty rubber hose

Rubair hose is double reinforced to fulfil all general heavy duty demands and is recommended for indoor and outdoor use. Rubair hose is oil resistant.

- Durable.
- Antistatic.
- Grinding and welding spatter resistant.
- Working temperature -20°C to +80°C.

Model	Hose inside dia		Hose outside dia mm	Max working pressure ^a bar	Max rec. air flow ^b	Weight per 20m coil	Ordering No.
	mm	in			l/s	kg	
RUBBER 10	10	3/8	16.0	16	13	3.6	9093 0057 91
RUBBER 13	12.5	1/2	19.1	16	21	4.7	9093 0057 93
RUBBER 16	16	5/8	23.0	16	43	6.1	9093 0057 31
RUBBER 20	20	3/4	26.6	16	75	7.8	9093 0057 33

^a With a safety factor of 4 at 20°C.

^b The pressure drop will be 0.2 bar on a hose length of 5 m, including 2 nipples and at an inlet pressure of 7 bar.

Hoses



CABLAIR

Super-light flexible PVC-hose

Cablair is made of high-strength and high performance PVC compound. The Cablair hose weighs 30–50% less, is much softer and more flexible than conventional PVC hoses.

- Low weight.
- Extremely soft and flexible.
- Silicone free.
- Ergonomic.
- Working temperature -15°C to +60°C.

Model	Hose inside dia		Hose outside dia mm		Max working pressure ^a bar	Max rec. air flow ^b	Weight per	Ordering No.
	mm	in				l/s	30 m coil kg	
CABLAIR 06	6	1/4	8.5		14	4	1.2	9093 0035 11
CABLAIR 08	8	1/3	11		14	7.5	1.7	9093 0035 41
CABLAIR 10	10	2/5	13		12	13	2.1	9093 0035 71
CABLAIR 13	12.5	1/2	16		11	21	3.0	9093 0036 01
CABLAIR 16	16	5/8	21		8	43	5.4	9093 0036 31
CABLAIR 20	19	3/4	24		8	75	5.8	9093 0036 61
CABLAIR 25	25	1	31.5		7	125	10.4	9093 0036 91

^aWith a safety factor of 3 at 20°C (at the max temp of +60°C the working pressure should be reduced by 50%).

^bThe pressure drop will be 0.2 bar on a hose length of 5 m.



CABLAIR ESD

Extra flexible antistatic air hose

Cablair ESD is designed specifically for the computer manufacturing industry. The hose possesses properties which enable ESDS (electrostatic sensitive devices) to be handled in a protected area with a low risk level, as a result of electrostatic discharge. The connection device must be earthed/grounded.

- Extra flexible.
- Antistatic.
- Silicone free.
- Testing in accordance with BS ISO 2878:2005.
- Working temperature -15°C to +60°C.

Model	Hose inside dia		Hose outside dia		Max working pressure ^a bar	Max rec. air flow ^b	Weight per	Ordering No.
	mm	in	mm	in		l/s	30 m coil kg	
CABLAIR ESD 06	6	1/4	12	7/16	10	4	2.34	8202 0501 06
CABLAIR ESD 08	8	5/16	17	1/2	9	7.5	2.56	8202 0501 08
CABLAIR ESD 10	10	3/8	22	9/16	8	13	2.71	8202 0501 10
CABLAIR ESD 13	13	1/2	25	23/32	7	21	4.41	8202 0501 13

^aWith a safety factor of 3 at 20°C (at the max temp of +60°C the working pressure should be reduced by 50%).



PVC

Hose for heavy-duty applications

PVC hose has high resistance to abrasion, which makes it the ideal hose for tough working environments. It is mainly recommended for indoor use.

- Long service life.
- Pliable.
- Transparent.
- Working temperature -15°C to +60°C.

Model	Hose inside dia		Hose outside dia mm	Max working pressure ^a bar	Max rec. air flow ^b	Weight per 20m coil	Ordering No.
	mm	in			l/s	kg	
PVC 03	3.2	1/8	7	20	0.7	1.4	9093 0037 21
PVC 05	5	3/16	9	10	2.1	1.9	9093 0037 51
PVC 06	6.3	1/4	11	10	4	2.5	9093 0037 81
PVC 08	8	5/16	12	10	7.5	2.9	9093 0038 11
PVC 10	10	3/8	14	14	13	3.7	9093 0038 41
PVC 13	12.5	1/2	18	13	21	5.9	9093 0038 71
PVC 16	16	5/8	22	12	43	7.2	9093 0039 01
PVC 20	19	3/4	25	10	75	8.3	9093 0039 31
PVC 25	25	1	32	10	125	12.5	9093 0039 61

^a With a safety factor of 3 at 20°C (at the max temp of +60°C the working pressure should be reduced by 50%).

^b The pressure drop will be 0.2 bar on a hose length of 5 m.

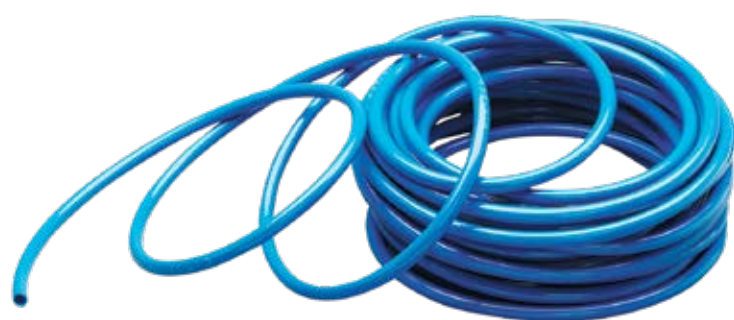

POLUR

High resistance polyurethane hose

Polur hose is the most environmentally friendly solution. It has high resistance to abrasion and it is oil resistant. Polur hose has a much longer lifetime than PVC hoses. Polur is ideal in tough working conditions due to its flexibility, even at minus degrees. Polur is recommended for indoor and outdoor use.

- Oil resistant.
- Flexible.
- Long service life.
- Working temperature -30°C to +60°C.

Model	Hose inside dia		Hose outside dia mm	Max working pressure ^a bar	Max rec. air flow ^b	Weight per 25 m coli	Ordering No.
	mm	in			l/s	kg	
POLUR 08	8	5/16	12	20	7.5	2.2	8202 0601 08
POLUR 10	10	3/8	14	16	13	2.5	8202 0602 10
POLUR 13	13	1/2	18	13	21	4.0	8202 0603 13

^a With a safety factor of 3 at 20°C (at the max temp of +60°C the working pressure should be reduced by 50%).

^b The pressure drop will be 0.2 bar on a hose length of 5 m, including 2 nipples and at an inlet pressure of 7 bar.

Spiral hoses

SPI

Elastic hose for vertical and horizontal applications

SPI elastic spiral hose is ideal for air tools used at varying distances from a fixed air outlet. It is easily stretched and retracts immediately when released. When used with hand tools, its self-storage principle ensures that the hose is kept off the floor and out of the way of the operator. The SPI 1 and SPI 2 have ball bearing swivels fitted on the long hose side to allow 360° rotation. All spiral hoses, except the SPI4, are fitted with plastic spring guard. SPI is the ideal hose in combination with a balancer.

- Self-retractable.
- Light and flexible.
- Strong and durable.
- Tubing material: Polyurethane (100% PUR).
- Hardness: Shore A 98 +2.
- Colour: Blue.
- Working pressure: 8 bar at 23°C.
- Burst pressure: 25 bar at 23°C.
- Temperature range: -40°C to +70°C.



Model	Hose inside dia	Hose outside dia	Max rec. air flow ^a	Working range	Length			Max spiral dia	Male threads in BSP	Ordering No.
	mm	mm			(A) mm	(B) mm	(C) mm			
SPI 1SPSW-S	6.5	10	7	2	500	165	150	55	1/4	8202 0508 71
SPI 1SPSW-M	6.5	10	5	4	500	330	150	55	1/4	8202 0508 73
SPI 2SPSW-S	8	12	13	2	500	130	150	70	3/8	8202 0508 75
SPI 2SPSW-M	8	12	10	4	500	270	150	70	3/8	8202 0508 77
SPI 2SPSW-L	8	12	9	6	500	435	150	70	3/8	8202 0508 79
SPI 2SPSW-XL	8	12	6	8	500	600	150	70	3/8	8202 0508 81
SPI 4SP-XXL	13	19	21	10	500	850	500	115	3/8	8202 0508 90

^a At inlet pressure 6 bar and pressure drop 0.5 bar.

Dimensions

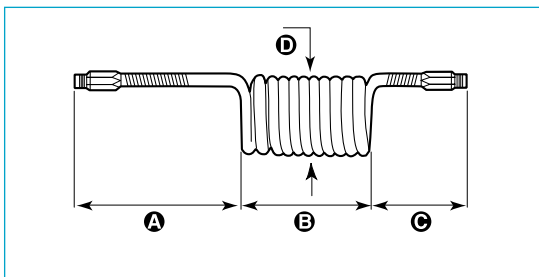

Productivity

kits

Productivity kits boost productivity, extend tool lifetime and ensure minimum pressure drop. Just choose the correct productivity kit based on the air flow requirement of the tool and whether the tool needs lubrication or not. You'll be surprised how much the productivity kit improves the performance of the tool.

- Improves the performance of the tool.
- Fast and easy installation.
- Extends tool lifetime.



PRODUCTIVITY KITS FOR FAST AIR TOOLS CONNECTION - "PLUG AND PLAY SOLUTION". ORDERING ONE OF THIS ITEMS YOU WILL GET ASSEMBLED AIR PREPARATION UNIT WITH THE COUPLINGS AND HOSES.

Model	Max air flow	Hose, 5 m	Coupling	Lubrication	Nipple for tool air inlet, ErgoNIP	Ordering No.
MIDI-FRL-1/2-BSP EQ08-C06-1/8	4 l/s	Cabclair 6 mm	ErgoQIC 08	Yes	1/8" & 1/4"	8202 0850 10
MIDI-F/R-1/2-BSP EQ08-C06-1/8	4 l/s	Cabclair 6 mm	ErgoQIC 08	No	1/8"	8202 0850 19
MIDI-FRL-1/2-BSP EQ08-C08	7.5 l/s	Cabclair 8 mm	ErgoQIC 08	Yes	1/4"	8202 0850 00
MIDI-F/R-1/2-BSP EQ08-C08	7.5 l/s	Cabclair 8 mm	ErgoQIC 08	No	1/4"	8202 0850 01
MIDI-FRL-1/2-BSP EQ08-C10	13 l/s	Cabclair 10 mm	ErgoQIC 08	Yes	3/8"	8202 0850 07
MIDI-FRL-1/2-BSP EQ08-C10	13 l/s	Cabclair 10 mm	ErgoQIC 08	Yes	1/4"	8202 0850 03
MIDI-FRL-1/2-BSP EQ10-R10	13 l/s	Rubair 10 mm	ErgoQIC 10	Yes	1/4"	8202 0850 16
MIDI-FRL-1/2-BSP EQ10-R13-W	21 l/s	Rubair 13 mm	ErgoQIC 10	Yes	3/8"	8202 0850 14
MIDI-FRL-1/2-BSP EQ10-C13	21 l/s	Cabclair 13 mm	ErgoQIC 10	Yes	3/8"	8202 0850 02
MIDI-FRL-1/2-BSP EQ10-C13	21 l/s	Cabclair 13 mm	ErgoQIC 10	Yes	1/4"	8202 0850 11
MIDI-FRL-1/2-BSP EQ10-T13	21 l/s	Turbo 13 mm	ErgoQIC 10	Yes	3/8"	8202 0850 17
MIDI-FRL-1/2-BSP EQ10-T16 (For LSV39)	43 l/s	Turbo 16 mm	ErgoQIC 10	Yes	3/8"	8202 0850 42
MIDI-F/R-1/2-BSP EQ10-T13	21 l/s	Turbo 13 mm	ErgoQIC 10	No	3/8"	8202 0850 04
MIDI-FRL-1/2-BSP EQ10-T13	21 l/s	Turbo 13 mm	ErgoQIC 10	Yes	1/2"	8202 0850 13
MIDI-FRL-1/2-BSP EQ10-T16	43 l/s	Turbo 16 mm	ErgoQIC 10	Yes	1/2"	8202 0850 12
MAXI-F/R-1-BSP C-T16	43 l/s	Turbo 16 mm	Claw & ErgoQIC10	No	1/2"	8202 0850 05

Productivity kit includes: Ball valve, air preparation unit (with lubricator or without it depending on the model), mounting kit to the wall, assembly kit to connect the modules, Quick coupling with hose nipple, 5 meters hose, one more quick coupling (with nipple to the tool or without it depending on the model). Kit comes completely assembled and ready to use. Oil should be ordered separately.

Hose

kits

Pre-mounted hose kits

Atlas Copco hose kits provides an easy way to choose the right hose and coupling combination for pneumatic tools. Each kit is ready for immediate use without the need of assembly tools.

- Correct combination hose – coupling.
- Leak free hose connections.
- Immediate use.



HOSE KITS

Hose	Hose inside dia	Length	Nipple	Coupling	Air inlet thread nipple	Ordering No.
	mm	m				
Cablaair	6	5	ErgoNIP 08	ErgoQIC 08	1/8" BSP & 1/4" BSP	8202 1182 01
Cablaair	6	5	ErgoNIP 10	ErgoQIC 08	1/8" BSP & 1/4" BSP	8202 1180 67
Cablaair	8	5	ErgoNIP 08	ErgoQIC 08	1/4" BSP	8202 1182 02
Cablaair	8	5	NIP 08	ErgoQIC 08US	1/8" NPT	8202 1182 21
Cablaair	8	5	ErgoNIP 10	ErgoQIC 08	1/4" BSP	8202 1180 77
Cablaair	10	5	ErgoNIP 08	ErgoQIC 08	1/4" BSP	8202 1182 03
PVC	10	5	ErgoNIP 10	ErgoQIC 08	1/4" BSP & 3/8" BSP	8202 1180 30
Cablaair	12.5	5	ErgoNIP 10	ErgoQIC 10	3/8" BSP	8202 1180 79
Cablaair	12.5	5	ErgoNIP 10	ErgoQIC 10	-	8202 1182 10
Cablaair	12.5	5	NIP 10US	ErgoQIC 10US	3/8" NPT	8202 1182 18
Cablaair	12.5	8.5	ErgoNIP 10	ErgoQIC 10	-	8202 1182 20
Cablaair	12.5	10	ErgoNIP 10	ErgoQIC 10	-	8202 1182 15
PVC	10	5	ErgoNIP 10	ErgoQIC 10	1/4" BSP	8202 1180 18
PVC	10	5	ErgoNIP 10	ErgoQIC 08	3/8" BSP	8202 1180 31
Rubair	10	5	ErgoNIP 10	ErgoQIC 10	3/8" BSP	8202 1180 20
Rubair	10	5	ErgoNIP 10	ErgoQIC 10	1/4" BSP	8202 1180 43
Rubair	12.5	5	NIP 10US	ErgoQIC 10US	3/8" NPT	8202 1182 24
Rubair	20	5	CLAW	ErgoQIC 10	-	8202 1180 24
Turbo	12.5	5	ErgoNIP 10	ErgoQIC 10	3/8" BSP	8202 1182 07
Turbo	12.5	5	ErgoNIP 10	ErgoQIC 10	1/2" BSP	8202 1180 22
Turbo	12.5	5	NIP 10US	ErgoQIC 10US	3/8" NPT	8202 1182 19
Turbo	16.8	5	ErgoNIP 10	ErgoQIC 10	1/2" BSP	8202 1180 34
Turbo	16.8	5	CLAW	ErgoQIC 10	1/2" BSP	8202 1181 80
Turbo	16.8	5	NIP 15US	ErgoQIC 15US	-	8202 1182 22
Turbo	16.8	10	ErgoNIP 10	ErgoQIC 10	-	8202 1180 46
Turbo	21	20	CLAW	ErgoQIC 10	-	8202 1181 75
Turbo	16	5	ErgoNIP-10	ErgoQIC 10	3/8" BSP	8202 1180 51

Pre-mounted whip hoses

If a quick coupling is used together with a vibrating tool, such as a percussive tool, impact wrench, grinder or impulse tool, we recommend it should be separated from the tool by a whip hose (length 0.5 m).



WHIP HOSE KITS

Hose	Hose inside dia	Length	Nipple	Hose nipple male thread	Ordering No.
	mm	m			
Cablaair	10	0.7	ErgoNIP 10	1/4" BSPT	8202 1180 19
Cablaair	10	1.5	ErgoNIP 10	1/4" BSPT	8202 1182 30
Cablaair	10	1.5	ErgoNIP 10	3/8" BSPT	8202 1182 35
Cablaair	10	0.7	ErgoNIP 08	1/4" BSPT	8202 1180 47
PVC	10	0.7	ErgoNIP 08	3/8" BSPT	8202 1180 50
Rubair	10	0.7	ErgoNIP 10	1/4" BSPT	8202 1180 42
Rubair	10	0.7	ErgoNIP 10	3/8" BSPT	8202 1180 44
Rubair	12.5	0.7	ErgoNIP 10	1/2" BSPT	8202 1180 23
Turbo	16.8	0.5	ErgoNIP 10	1/2" BSPT	8202 1180 28
Turbo	16.8	5	CLAW	1/2" BSPT	8202 1181 95

Hose kit includes male thread hose nipple for the tool air inlet

Pre-mounted hose kits

Atlas Copco SmartQIC hose kits provides an easy & safe way to choose the right hose and coupling combination for pneumatic tools. Each kit is ready for immediate use without the need of assembly tools.

- Correct combination hose – coupling.
- Leak free hose connections.
- Plug & Play



HOSE KITS AND WHIP HOSES

Market		Application	Hose type	Nipple for the tool included	Max rec. air flow	Max working pressure	Hose length	Ordering No.	
					l/s	bar	m		
EU 7.6									
SmartQIC 08E	Hose kit	Assembly	CABLAIR 08	1/4" BSP	7.5	14	5 (16.4)	4221 0000 80	
		Assembly	CABLAIR 10	1/4" and 3/8" BSP	13	12	5 (16.4)	4221 0000 81	
		Assembly	CABLAIR 10	1/4" and 3/8" BSP	13	12	10 (32.8)	4221 0000 82	
		Assembly	CABLAIR 13	3/8" and 1/2" BSP	21	11	5 (16.4)	4221 0000 85	
		Assembly	CABLAIR 13	3/8" and 1/2" BSP	21	11	10 (32.8)	4221 0000 86	
		Heavy Duty	TURBO 13	3/8" and 1/2" BSP	21	20	5 (16.4)	4221 0000 83	
	Heavy Duty	TURBO 13	3/8" and 1/2" BSP	21	20	10 (32.8)	4221 0000 84		
	Whip hose	Assembly	CABLAIR 08	1/4" BSPT	7.5	14	1 (3.3)	4221 0001 09	
		Assembly	CABLAIR 10	3/8" BSPT	13	12	1 (3.3)	4221 0001 10	
		Assembly	CABLAIR 13	3/8" BSPT	21	11	1 (3.3)	4221 0001 11	
EU 10.4									
SmartQIC 15E	Hose kit	Assembly	CABLAIR 13	3/8" and 1/2" BSP	21	11	5 (16.4)	4221 0000 89	
		Assembly	CABLAIR 13	3/8" and 1/2" BSP	21	11	10 (32.8)	4221 0000 90	
		Heavy Duty	TURBO 13	3/8" and 1/2" BSP	21	20	5 (16.4)	4221 0000 87	
		Heavy Duty	TURBO 13	3/8" and 1/2" BSP	21	20	10 (32.8)	4221 0000 88	
		Heavy Duty	TURBO 16	1/2" and 3/4" BSP	43	20	5 (16.4)	4221 0000 91	
		Heavy Duty	TURBO 16	1/2" and 3/4" BSP	43	20	10 (32.8)	4221 0000 92	
	Whip hose	Heavy Duty	TURBO 16	3/8" BSPT	21	20	1 (3.3)	4221 0001 12	
		Heavy Duty	TURBO 13	1/2" BSPT	43	20	1 (3.3)	4221 0001 13	
	ISO 6150-B – US/Global								
	SmartQIC 08US	Hose kit	Assembly	CABLAIR 08	1/4" NPT	7.5	14	5 (16.4)	4221 0000 93
Assembly			CABLAIR 10	1/4" and 3/8" NPT	13	12	5 (32.8)	4221 0000 94	
Assembly			CABLAIR 10	1/4" and 3/8" NPT	13	12	10 (16.4)	4221 0000 95	
Whip hose		Assembly	CABLAIR 10	3/8" BSPT	13	12	1 (3.3)	4221 0001 14	
SmartQIC 10US	Hose kit	Assembly	CABLAIR 10	1/4" and 3/8" NPT	13	12	5 (16.4)	4221 0001 01	
		Assembly	CABLAIR 10	1/4" and 3/8" NPT	13	12	10 (32.8)	4221 0001 02	
		Assembly	CABLAIR 13	3/8" and 1/2" NPT	21	11	5 (16.4)	4221 0001 05	
		Assembly	CABLAIR 13	3/8" and 1/2" NPT	21	11	10 (32.8)	4221 0001 06	
		Heavy Duty	TURBO 13	3/8" and 1/2" NPT	21	20	5 (16.4)	4221 0001 03	
		Heavy Duty	TURBO 13	3/8" and 1/2" NPT	21	20	10 (32.8)	4221 0001 04	
	Whip hose	Assembly	CABLAIR 10	3/8" BSPT	13	12	1 (3.3)	4221 0001 17	
		Assembly	CABLAIR 13	3/8" BSPT	21	11	1 (3.3)	4221 0001 18	
		Assembly	TURBO 13	3/8" BSPT	21	20	1 (3.3)	4221 0001 19	
SmartQIC 15US	Hose kit	Assembly	CABLAIR 13	3/8" and 1/2" NPT	21	11	5 (16.4)	4221 0000 97	
		Assembly	CABLAIR 13	3/8" and 1/2" NPT	21	11	10 (32.8)	4221 0000 98	
		Heavy Duty	TURBO 13	3/8" and 1/2" NPT	21	20	5 (16.4)	4221 0000 96	
		Heavy Duty	TURBO 20	1/2" and 3/4" NPT	75	20	5 (16.4)	4221 0000 99	
		Heavy Duty	TURBO 20	1/2" and 3/4" NPT	75	20	10 (32.8)	4221 0001 00	
	Whip hose	Assembly	CABLAIR 13	3/8" BSPT	21	11	1 (3.3)	4221 0001 15	
		Heavy Duty	TURBO 13	3/8" BSPT	21	20	1 (3.3)	4221 0001 16	
Asia									
SmartQIC 10A	Hose kit	Assembly	CABLAIR 08	1/4" BSP	7.5	14	5 (16.4)	4221 0001 07	
		Assembly	CABLAIR 10	1/4" and 3/8" BSP	13	12	5 (16.4)	4221 0001 08	

HOSE REELS



Selection

Guide

Imagine your work area free from hoses so you no longer need to worry about tripping over them! Atlas Copco hose reels are the optimal solution. Your tools will always benefit from a high air flow with a small pressure drop when using Atlas Copco hose reels – and you will have all the benefits of a tidy workplace.

HM Light	HM Open	HM Flex L	HH Open XL
	 		
<p data-bbox="121 1176 312 1200">Small screwdrivers</p>  <p data-bbox="121 1301 233 1352">Small vane grinders</p>  <p data-bbox="121 1429 233 1480">Small vane grinders</p> 	<p data-bbox="480 1317 587 1368">Percussive tools</p>  <p data-bbox="699 1176 754 1200">Drills</p>  <p data-bbox="699 1317 930 1346">Medium vane grinders</p>  <p data-bbox="699 1469 962 1498">Medium impact wrenches</p> 	<p data-bbox="1161 1176 1281 1227">Large vane grinders</p>  <p data-bbox="1161 1294 1305 1346">Large turbine grinders</p>  <p data-bbox="1161 1413 1302 1464">Large impact wrenches</p> 	
0–10 l/s	10–22 l/s	22–95 l/s	

Hose reels

HM LIGHT

The HM Light has a robust design with a high impact composite casing. The outlet slot is optimized to provide an ideal pull-out angle for the hose. The HM Light is recommended for small and medium screwdrivers, small and medium pulse tools, small drills, impact wrenches up to 1/2" size and riveting and chipping hammers.

- Snap-on, pivoting wall bracket.
- PVC/PUR hose.
- Hose end provided with pressed fitting and steel spiral hose protector (NPT and BSP).
- Hose easily replaced when needed.
- Drum with ball bearings on both sides.
- Working temperature: 0°C - +50°C.
- Inlet hose length: 1 m.



Model	Hose length	Hose type	Hose inside dia		Connection inlet hose inside dia (cut of hose)	Connection distribution hose	Max working pressure	Economical air flow (at 0.2 bar pressure drop)	Max air flow capacity (at 0.5 bar pressure drop)	Weight	Ordering No.
	m		l/s	m	mm	BSP	bar	l/s	l/s		
HM LIGHT 8-8	8	PVC/PUR	8	5/16	10	1/4	12	4	7	3	8202 1183 30
HM LIGHT 8-12	12	PVC/PUR	8	5/16	10	1/4	15	3	5	5	8202 1183 31
HM LIGHT 10-10	10	PVC/PUR	10	3/8	10	3/8	15	6	10	5	8202 1183 32

Dimensions

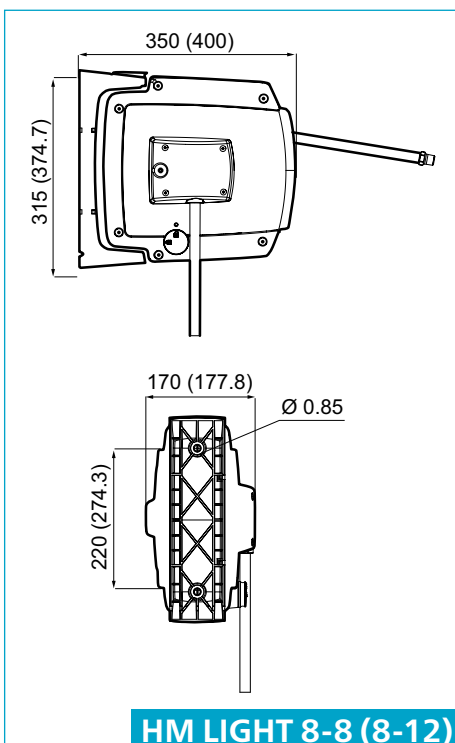

Flow chart

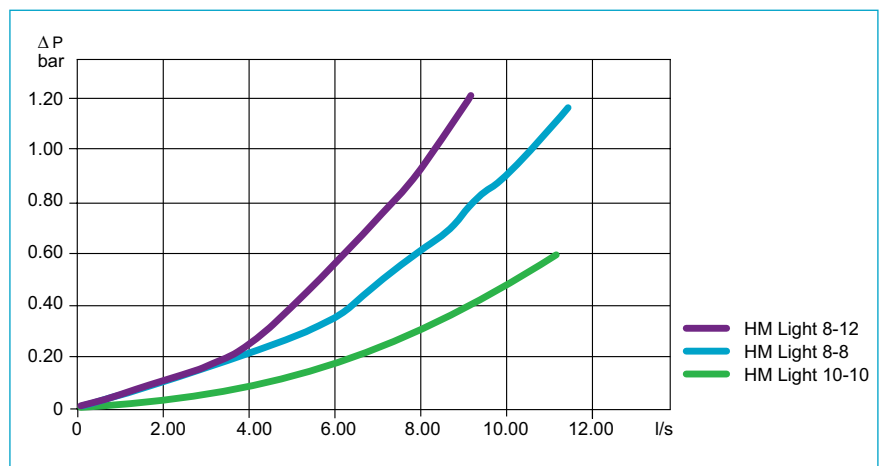

HM OPEN

The HM Open has an open composite casing, steel frame and 10 mm or 13 mm hose. HM Open is a reliable, medium sized hose reel recommended for screwdrivers, impact wrenches, pulse tools, drills, chipping and riveting hammers and grinders up 1000 W.

- Spatter resistant rubber hose.
- Outlet roller position can be adjusted through 120 degrees for optimal pull-out angle.
- Hose end provided with steel spiral hose protector (BSP).
- Latch function is easily disengaged.
- Spring tension is easily adjusted.
- Floor, wall or ceiling mounting.
- Working temperature: -10°C - +60°C.
- Max working pressure: 15 bar.
- Inlet hose length: 1 m.



Model	Hose length	Hose type	Hose inside dia		Connection inlet hose inside dia (cut of hose)	Connection distribution hose	Economical air flow (at 0.2 bar pressure drop)	Max air flow capacity (at 0.5 bar pressure drop)	Weight	Ordering No.
	m		l/s	m	mm	BSP	l/s	l/s		
HM OPEN 10-15	15	Rubber	10	3/8	12.5	3/8	5	9	11	8202 1183 33
HM OPEN 10-20	20	Rubber	10	3/8	12.5	3/8	5	7	14	8202 1183 34
HM OPEN 12-10	10	Rubber	12.5	1/2	12.5	1/2	13	22	12	8202 1183 35
HM OPEN 12-15	15	Rubber	12.5	1/2	12.5	1/2	11	17	13	8202 1183 36

Pivoting wall brackets needs to be ordered separately.

Dimensions

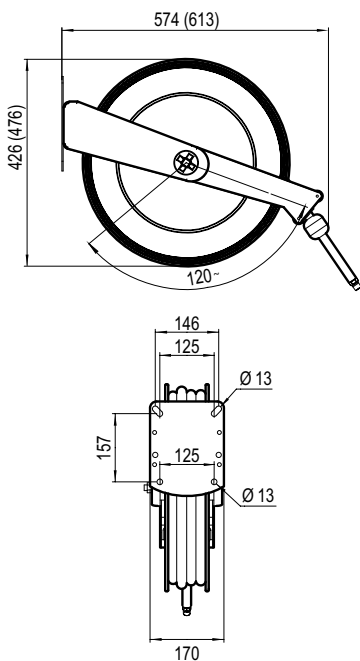

HM Open 12-10 (12-15)

Flow chart

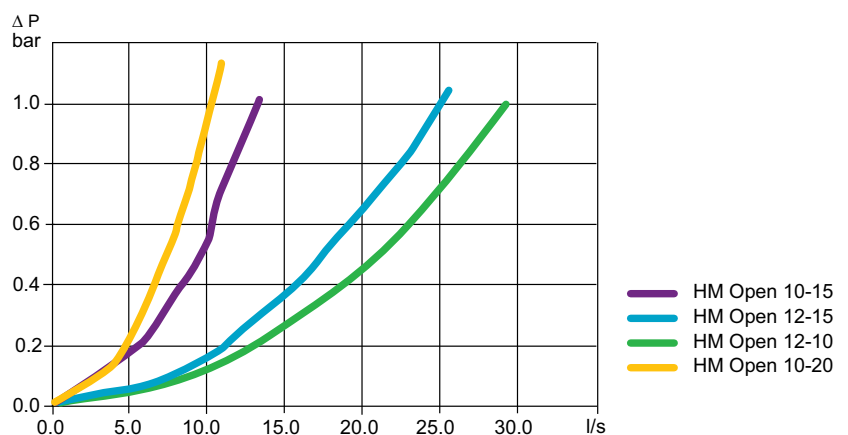

Accessories

	Ordering No.
Pivoting wall bracket	4390 2080 10

Hose reels

HM OPEN XL

Hose reels in the HM Open XL series have an open die cast aluminium casing and 3/8" or 1/2" hose. HM Open XL hose reels are recommended for screwdrivers, impact wrenches, pulse tools, drills, chipping and riveting hammers and high powered grinders.

- Spatter resistant rubber hose.
- Floor, wall or ceiling mounting.
- Revolving hinge for flexible use.
- Working temperature: -10°C - +60°C.
- Max working pressure: 15 bar.
- Inlet hose length: 1 m.



Model	Hose length	Hose type	Hose inside dia		Connection inlet hose inside dia (cut of hose)	Connection distribution hose	Economical air flow (at 0.2 bar pressure drop)	Max air flow capacity (at 0.5 bar pressure drop)	Weight	Ordering No.
	m		mm	in	mm	BSP	l/s	l/s		
HM OPEN XL 12-20	20	Rubber	12.5	1/2	12.5	1/2	8	14	27	8202 1183 37
HM OPEN XL 12-30	30	Rubber	12.5	1/2	12.5	1/2	8	12	28	8202 1183 38
HM OPEN XL 19-15	15	Rubber	19	3/4	19	3/4	27	44	28	8202 1183 39
HM OPEN XL 25-10	10	Rubber	25	1	25	1	60	95	30	8202 1183 40

Pivoting wall brackets needs to be ordered separately.

Dimensions

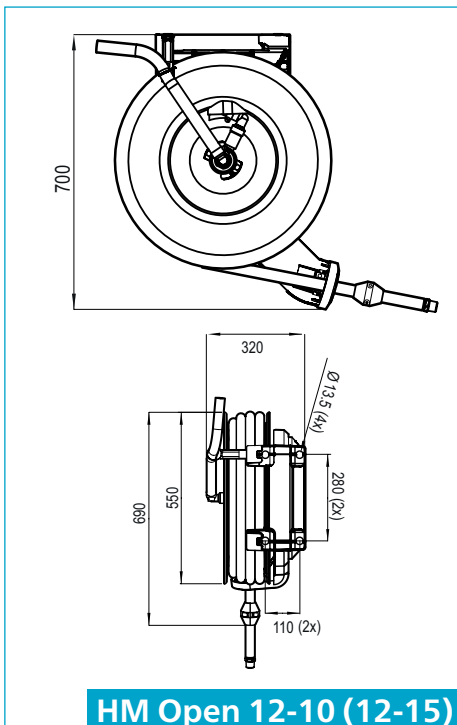

Flow chart

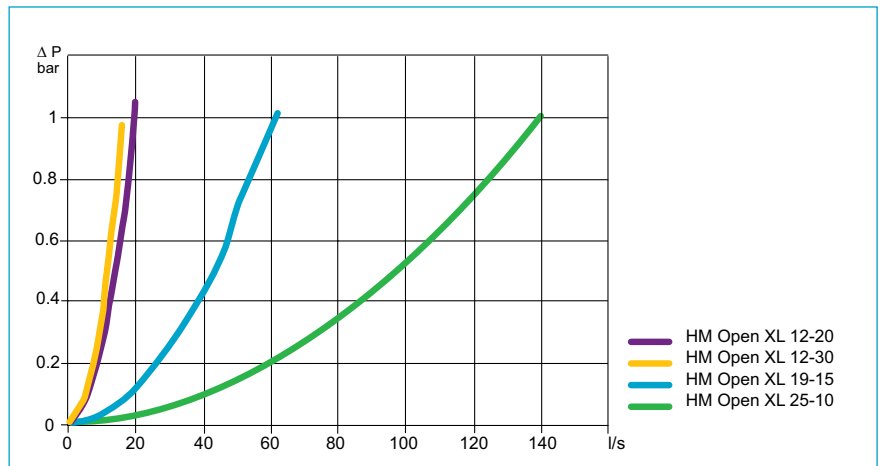

Accessories

	Ordering No.
Pivoting wall bracket	4390 2080 11

HM FLEX L

The HM FLEX L, with a steel casing and high quality rubber hose, handles both air and water. The HM FLEX L is recommended for all screwdrivers, pulse tools, impact wrenches, drills, chipping and riveting hammers and grinders up to 1000 W.

- NBR rubber hose.
- Movable brackets for floor, wall and ceiling mounting.
- High flow capacity.
- Working temperature: -30°C - +60°C.
- Max working pressure is 15 bar.
- Inlet hose length: 1 m.



Model	Length	Hose	Hose inside dia		Connection inlet BSP male	Connection distribution hose BSP male	Air flow	Weight	Ordering No.
	m		mm	in	BSP	l/s	l/s	kg	
HM FLEX L	10	Rubber	12.5	1/2	1/2	1/2	22	16	8202 1181 56

Dimensions

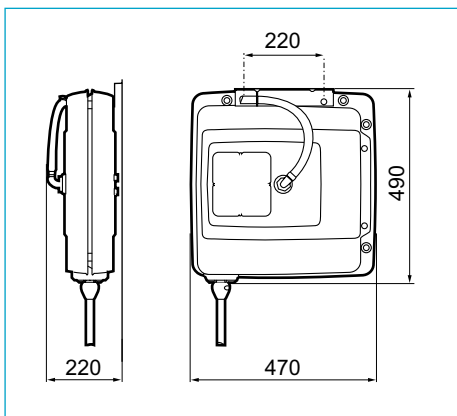

Blow guns

and test equipment

Blow Gun BG-series

Atlas Copco blow guns BG-series are hard wearing, user friendly solution for all cleaning applications. The plastic body offer flexibility in handling for both left and right handed users, it insulate against cold and it reduce the risk of scratches to worksurfaces. The blow gun has excellent throtteling properties allowing easy regulation of the air flow. The blow guns have air inlet thread in brass that is fully covered by the plastic body. Two versions available with star tip to reduce risk of damages or injuries if the tube is pressed against workpiece or skin.

- High flow capacity.
- Suspension.
- Plastic body to avoid scratches.
- Air inlet thread in brass.
- Star tip availability for improved safety.
- Complies with OSHA STD1-13.1 and OSHA 1910.95.



Model	Version	Working pressure	Air flow	Weight		Air inlet thread BSP	Ordering No.
		bar	l/s	kg	lb		
BG 2603-HF	Long tube, high flow	6.3	7.5	0.13	0.29	1/4	8202 1006 04
BG 2604-SHF	Short tube	6.3	4.3	0.12	0.26	1/4	8202 1006 05
BG 2605-STSS	Short tube, star tip	6.3	6.6	0.12	0.26	1/4	8202 1006 06
BG 2606-ST5	Long tube, star tip, silencer	6.3	6.3	0.14	0.31	1/4	8202 1006 07

Test Equipment

PRESSURE CONTROL UNIT

The unit consists of a high quality pressure gauge and the necessary couplings for checking the air pressure at the air inlet of the machine.

Ordering No. 4145 0699 81.

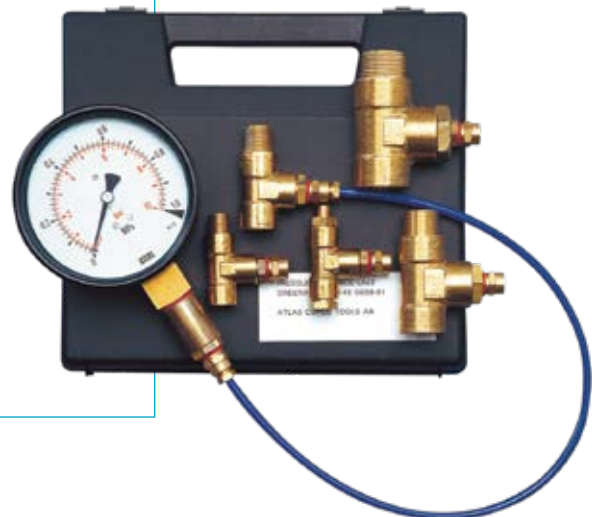

Product

safety

All local safety regulations with respect to installation, operation and overhaul must always be followed. Please read the separate instructions regarding safety which are supplied with all products in order to improve your own safety!

Ball valve

- Switch off the compressed air with the ball valve when you are not working (see fig. 1).
- Open all ball valves gently in order to discover improperly tightened devices (see fig. 5).

Air preparation units

- Please check for solvents which change the structure of polycarbonate bowls.

These solvents make the polycarbonate brittle so it can break. Normally polycarbonate is not easy to break. If you need to use aggressive solvents, please contact us and we will help you choose the right equipment.

- Use bowl guard.

An easy way to eliminate this type of accident is to use a bowl guard on MINI and MIDI units. The MAXI unit has an aluminum bowl with a new, more chemical resistant plastic on the inside as standard.

Check that the bowls are properly tightened and that all units are fitted together before switching on the compressed air with the ball valve.

Quick safety couplings

To increase safety and reduce the risk of operator injuries we recommend you to always buy couplings with a safety function. Couplings with a safety function are disconnected in two stages in order to vent the coupling and minimize the risk of sudden component separation, which has the potential to cause operator injury.

Never open a quick coupling with a screwdriver in order to ventilate the air.

Claw couplings

- Be very careful (see fig. 1+2+3).

They are always open and must be used very carefully.

To increase safety when using claw couplings, we recommend the claw LNH claw coupling with a lock nut.

Clamps and connections

- Avoid screwdrivers when tightening.

Check that they are properly tightened. Avoid screwdrivers when tightening, they can easily slip and damage your hand. Use a wrench. If you need to use a screwdriver, mount the clamp in a vice.

Hoses

When mounting hoses on hose connections, use water and soap in order to make the hose slip on to the connection.

Do not use oil. Water and soap will dry up. Remove leaking hoses. A small leakage can quickly become a large hole.

Blow guns

- Use the safety version. It eliminates the risk of air at high pressure coming into direct contact with skin.

^a Polycarbonate has good chemical resistance to all solvents except chemicals containing acetone, benzol, glycerine, some hydraulic and synthetic oils, chloroform, methyl alcohol, carbon tetrachloride (and similar solvents), carbon disulphide, perchloroethylene, toluene, trichloroethylene, xylene (nitrocellulose, thinner), acetic acid.

Follow this order when working with claw couplings:

1 How to open a claw coupling:

Close the ball valve.



2 Run the tool so the air ventilates out.



3 Release the claw coupling.

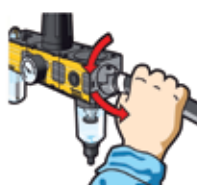

4 How to close a claw coupling:

Make sure that the two claw couplings are mounted together.

Use claw couplings with lock nut (LNH) or use a lock spring for safer locking.



5 Open the ball valve gently.





HOME OF INDUSTRIAL IDEAS — SERVING THE INDUSTRY SINCE 1873



W2620 / W2621



S8050



Find about our ratchet wrenches
and electric screwdriver in
Fabrication and Maintenance
PRO range catalogue!

BRING A CENTURY OF EXPERIENCE TO
YOUR PROJECT



Atlas Copco AB
(publ) SE-105 23 Stockholm, Sweden
Phone: +46 8 743 80 00
Reg. no: 556014-2720
atlascopco.com

