



## ***Pocket guide to screwdriving***

*Atlas Copco*



# POCKET GUIDE TO SCREWDRIVING

<b>Chapter</b> .....	<b>Page</b>
<b>1. The screw</b> .....	<b>4</b>
A versatile fastener	
The scope of screwdrivers	
<b>2. The screw joint</b> .....	<b>6</b>
The tightening torque	
Quality influence of the tightening tool	
<b>3. Torque control of screwdrivers</b> .....	<b>11</b>
Slip-clutch	
Shut-off clutch	
Direct drive	
<b>4. Test methods</b> .....	<b>14</b>
Static measurement	
Dynamic measurement	
Screwdriver torque setting	
<b>5. Screwdriver selection</b> .....	<b>17</b>
Power source	
Air motor	
Universal electric motor	
Low voltage electric motor	
Battery powered motor	
Current controlled electric motor	
<b>6. Shape of tool</b> .....	<b>21</b>
Pistol grip screwdrivers	
Straight screwdrivers	
Angle head screwdrivers	
<b>7. Selection of performance data</b> .....	<b>23</b>
Speed	
Power	
<b>8. Select the screwdriver to suit the joint</b> .....	<b>25</b>
<b>9. Screwdriver accessories</b> .....	<b>26</b>
Screwdriver bits	
Survey of screwheads	
Balancers and torque arms	
Batch counting – line control	
ESD approval	
<b>10. Installation</b> .....	<b>30</b>
Air-powered screwdrivers	
Electric screwdrivers	
<b>11. Screwdriver economics</b> .....	<b>32</b>
<b>12. Trouble shooting chart</b> .....	<b>33</b>
<b>13. Atlas Copco pocket guides</b> .....	<b>34</b>

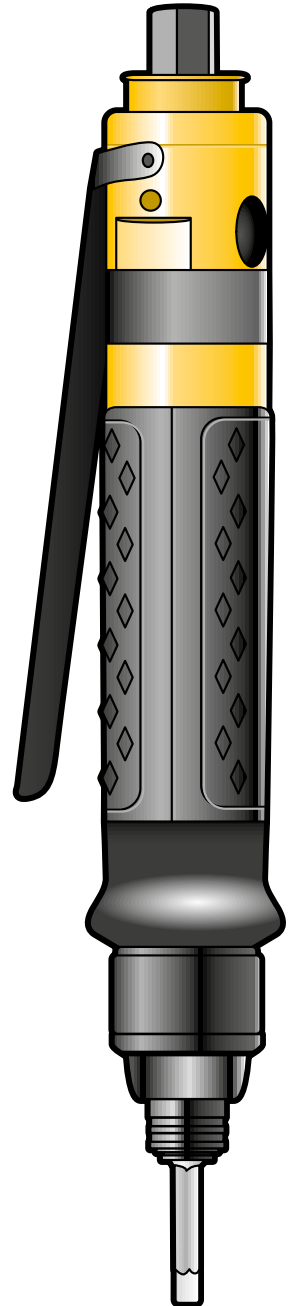

# 1. THE SCREW

## A versatile fastener

Easy assembly and disassembly makes the threaded fastener unmatched as a method for joining components. The screw joint is by far the commonest way to assemble mechanical devices of different types. Motor vehicles, aircraft, railway carriages, washing machines, television sets, IKEA furniture and mobile phones are all dependent on properly dimensioned and well-tightened screw joints to make assembly, handling, maintenance and repair profitable for producers and affordable for users. Screws for the purpose are available in a variety of types and sizes ranging from less than 1 millimeter up to several hundred millimeters. An ordinary motor car is put together with about 3,000 screws. If all these screws had to be tightened by hand, cars would be so expensive that very few people could afford to buy them. To make production rational and economic and maintain consistent quality, power tools are extensively used to tighten screws in industrial production and in commercially run service and maintenance operations.

## The scope of screwdrivers

Between 50 and 60% of the screws in a motor car and over 80% of the total number of all screws used in industrial production are up to and including 6 mm in diameter, i.e. sizes small enough to be handled with a manual screwdriver. Beyond this size range the torque required to create sufficient prestress in screws becomes so great that some kind of wrench is necessary. The same limitation applies to power tools used for tightening – not because of the tightening torque but because of the reaction torque that the operator will be subjected to. Accordingly, power tools for screw sizes up to M6 can be direct-driven tools of straight or pistol grip type that are called screwdrivers, whereas power tools for larger screw sizes are usually described as wrenches or nut-runners.

This booklet only covers screwdrivers and the specific conditions that apply to the tightening of screw joints in the capacity range where neither the driving force of the tool nor the reaction force to the hand of the operator are normally critical issues, at least not where just a single operation is concerned.

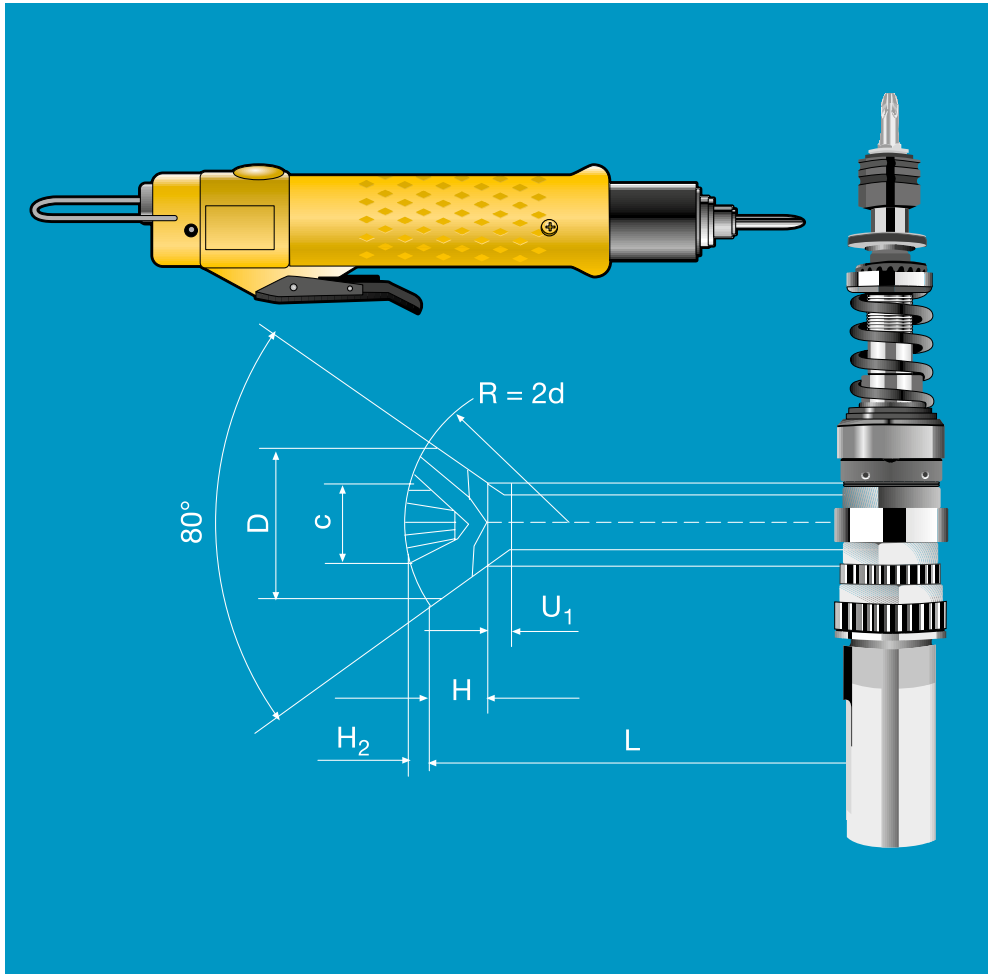

## 2. THE SCREW JOINT

The purpose of a screw joint is to hold the members of the joint together under the load conditions for which the joint is designed. Technically this means creating enough clamping force in the joint to withstand the forces that the joint may be subjected to without being loosened, but not enough clamping force to break any member of the joint. In a screw joint the clamping force is provided by tightening the screw to a prestress by converting rotary motion into linear elongation of the screw.

The decisive factor in the balance of forces is the friction in the joint that prevents the screw from loosening after setting. Essential as this friction is for the function of the joint, it also represents the major problem in tightening the joint. With ordinary machine screws, it takes as much as 90% of the total torque applied to the screw to overcome the friction and turn the screw. This means that only 10% of the power applied remains for stressing the screw and building up the clamping force. It is obvious that even small variations in friction caused by differences in lubrication or thread quality can have a considerable influence on the quality of the joint.

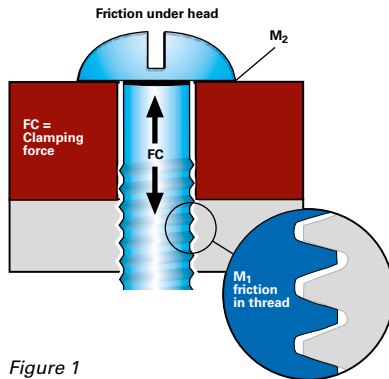

Figure 1

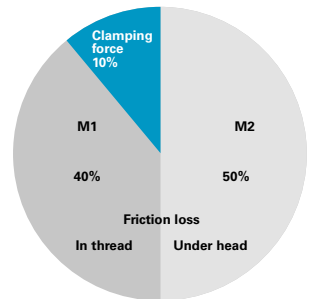
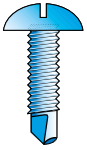
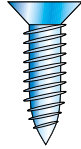

Figure 2

The problem of defining the correct torque is further complicated by the great variety of types of screws existing on the market in addition to the plain machine screw. Some examples are shown below.



*Self drilling fasteners. These screws drill and tap their own holes, thus eliminating a costly operation.*



*Self piercing screw. A screw to fasten all types of timber without the need to pre-drill a hole.*

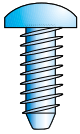

*Thread forming self tapping screw, type ST.*

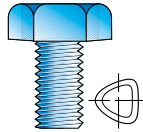

*Thread rolling screw. A coarse threaded trilobular screw designed for thermoplastics.*

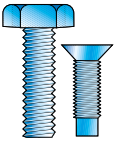

*Thread clearing screw. Used in pretapped holes clogged with paint, weld spatter or other foreign matter. Eliminates separate retapping operations.*

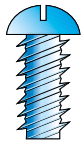

*Self tapping screw. In very soft thermoplastics this screw can achieve greater pull-off strength and can increase the difference between driving and stripping torque.*

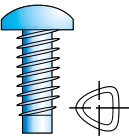

*Thread rolling screw. A tri-lobular self tapping screw with thread rolling action, suitable for ductile materials.*

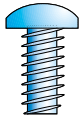

*Thread cutting screw. Suited particularly to brittle plastics.*

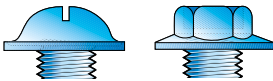

*Flange type heads.*

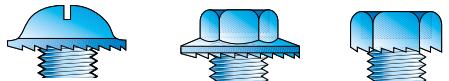

*Increased locking with grooves in head.*

*Different screw tips.*

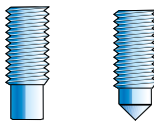

*Guide types*

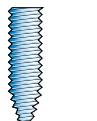

*Rotating guide*



*Drill type*

*Figure 3*

## The tightening torque

There is at present no method for direct measurement of the clamping force in a screw joint in practical production. This means in practice that, despite the uncertainty, the tightening torque is the only value usable for deciding the quality of screw joints. Screws are usually rated for a specific tightening torque with regard to size and tensile strength (bolt grade). This torque has generally been calculated to give a tension in the screw of approximately 60% of its tensile strength. At first sight this seems to provide a good margin for variations in tightening torque and yet result in proper clamping. However, considering the distribution of forces applied to the screw, it is obvious that even moderate variations in torque might lead to a joint that comes apart by itself or an over-tightening situation with screw breakage if thread conditions are not fully under control.

Another decisive factor in the tightening process is the torque rate, which is the turning angle from snug level to the rated tightening torque of the screw. A hard joint where the screw is short and the pieces being fastened together are rigid and tight requires only a fraction of a turn to reach the final torque, whereas a soft joint where the screw is long and/or there are resilient components such as spring washers or gaskets may require several full turns to reach its final prestress. It follows that the energy required to tighten a soft joint is greater than for a hard joint.



## Recommendations

*Recommended max tightening torque (Nm) for untreated lightly oiled screws, (friction coefficient = 0.125) Metric coarse thread.*

Thread	3.6	3.6	4.6	5.8	8.8	10.9	12.9
M1.6	0.05	0.065	0.086	0.11	0.17	0.24	0.29
M2	0.10	0.13	0.17	0.22	0.35	0.49	0.58
M2.2	0.13	0.17	0.23	0.29	0.46	0.64	0.77
M2.5	0.20	0.26	0.35	0.44	0.70	0.98	1.20
M3	0.35	0.46	0.61	0.77	1.20	1.70	2.10
M3.5	0.55	0.73	0.97	1.20	1.90	2.70	3.30
M4	0.81	1.10	1.40	1.80	2.90	4.00	4.90
M5	0.60	2.20	2.95	3.60	5.70	8.10	9.70
M6	2.80	3.70	4.90	6.10	9.80	14.0	17.0

Table 1

*The torques correspond to approximately 62% of tensile stress.*

*Note: If a screw locking element is included, increase torque by 10% for plastic insert and 20% for mechanical locking (prevailing nut).*

*Recommended tightening torque for thread rolling screws, Taptite®, Swageform® etc.*

*Recommended tightening torque for thread forming screw – ST (sheet metal screw).*

Thread	Torque Nm
M3	1.4
M4	3.2
M5	6.5
M6	11
M8	26
M10	52
M12	91

Thread	Torque Nm
ST 2.2 (B2)	0.2
ST 2.9 (B4)	1.0
ST 3.5 (B6)	1.8
ST 4.2 (B8)	2.9
ST 4.8 (B10)	4.2
ST 5.5 (B12)	6.7
ST 6.3 (B14)	9.1

Table 2 and 3

*Case-hardened, threadforming screws for metal. M thread. Recommended values apply to the strength of the screw (the joint may be weaker).*

*Recommended values apply to the strength of the screw (the joint may be weaker).*

## Quality influence of the tightening tool

*What influence can the selection of the tightening tool have on the quality of the screw joint?*

Different power screwdrivers have different qualities that are crucial for the final tightening result. One important factor is the speed of the tool and the dynamic influence it has on the applied torque. The applied torque is always the sum of the torque that the tool produces and the additional torque created by the stored energy of the mass of the rotating parts.

This is valid whether the driving motion is ended by a clutch or by stalling. In a hard joint this additional dynamic torque can have a considerable influence on the final torque and the higher the tool speed the greater is this influence. Conversely, in a soft joint the dynamic energy is not sufficient to add significantly to the turning angle and torque. The difference in the applied torque between a hard and a soft joint with the same tool is called the mean shift. Depending on speed, the quality of the clutch of the tool and the mass of the rotating parts, this mean shift varies from tool to tool. Consequently, the mean shift becomes another essential quality of the tool necessary to consider to be able to rely on the joint, even if the torque rate varies.

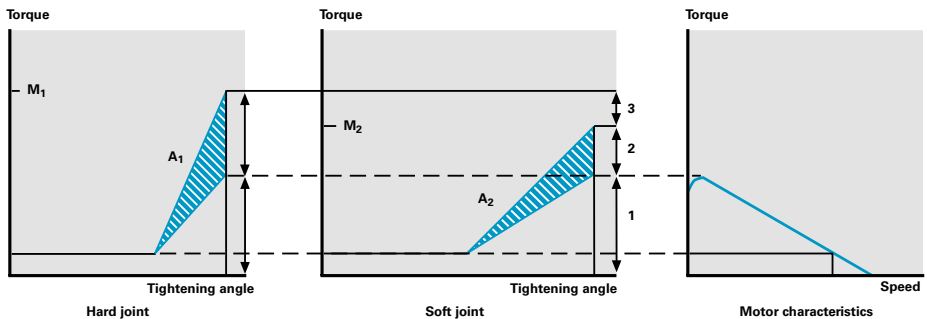

Figure 4. Dynamic energy influence on tightening torque

$M_1, M_2 =$  Final torque

1 = Motor torque

2 = Dynamic torque addition

3 = Mean shift

Area  $A_1 = A_2 =$  Dynamic energy

### 3. TORQUE CONTROL OF SCREWDRIVERS

Screwdrivers (meaning power tools) are usually equipped with an adjustable torque clutch. Air powered screwdrivers are also available as direct drive tools where the maximum applied torque is reached at stall of the motor. The common advantage of the tool with a clutch is that the dynamic effects on the applied torque are limited by disconnecting the power train from the drive shaft when the preset torque has been reached, thereby reducing the mass influence of motor and gears.

#### Slip clutch

The most common type of clutch for general-purpose screw driving is the friction clutch (slip clutch). The design is basically a spring-loaded claw coupling with inclined claws that slip when the torque exceeds the preset spring force. The claws continue to slam and slip until the operator releases the trigger. The torque applied is not very accurate and depends on how long the operator lets the tool slip, as the slam of the clutch when re-engaging adds energy to the joint, resulting in increased torque. However, this effect is sometimes an advantage, e.g. when there is a variation in the torque requirement for achieving a tight joint, which may be the case for thread forming screws or wood screws. Disadvantages of the slip clutch are the limited torque accuracy, the noise and vibration from the slipping action and the torque reaction to the operator. Apart from the ergonomic effects, the vibrations might also cause damage to screws and a high degree of wear on drive bits.

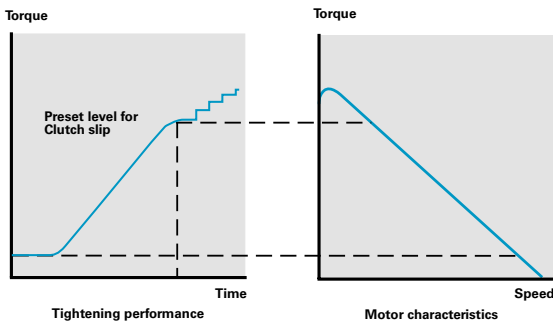

Figure 5. Slip clutch permits a certain torque addition after the preset level has been reached

## Shut-off clutch

For maximum torque accuracy with a minimum of operator influence a shut-off clutch screwdriver is preferred. The shutoff function can be either a pure mechanical action of disengagement between the output shaft and the drive train, a motor shut-off or a combination of both. However, the basic device is usually an adjustable spring-loaded clutch that releases torque transmission and stops motor rotation either directly by shutting off the air supply on an air powered screwdriver or indirectly by a signal to brake the electric motor of an electric tool.

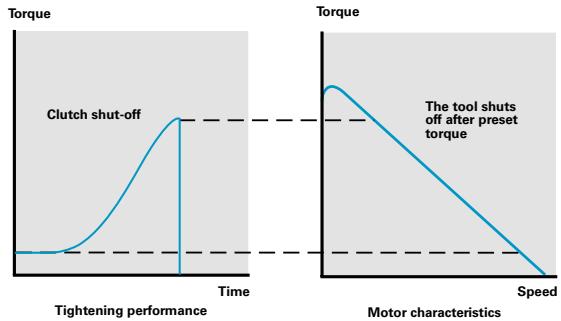

Figure 6. The tool shuts off after preset torque

The fact that a power screwdriver has a shut-off clutch is no guarantee of high quality accuracy. The design of the clutch is of decisive importance for screw tightening quality. The critical factor is the clutch reaction time from reaching the preset torque until full release resulting in a torque overshoot. It follows that slow clutch reaction means a greater difference between hard and soft joint than a quick release.

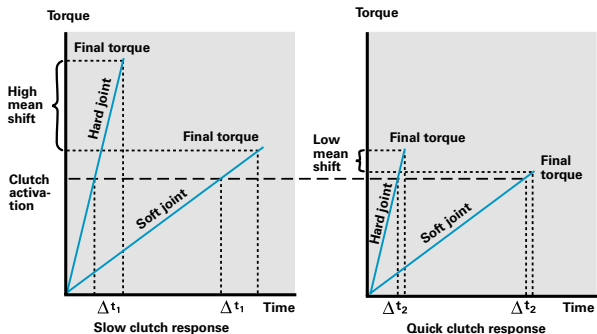

Figure 7. Clutch response time influence

The shut-off time is also crucial for the reaction torque. A high quality clutch with a short reaction time means that most of the reaction torque on hard joints will be absorbed by the mass of the tool, with hardly any jerk to the hand of the operator. The low noise level and little vibration of shutoff clutch tools result in better working ergonomics.

A smooth quick shut-off action with a minimum of jerk reduces the risk of recoil of the bit in its grip of the screw head, which means less damage to the finish of the screw head recess. Also, bit wear is reduced compared to slip clutch tools. 60-80% lower bit consumption is not unusual.

Moreover, power shut-off to the motor considerably reduces energy consumption compared to slip clutch models.

### Direct drive

Direct drive air tools, in which the bit that drives the screw has a direct connection to the output shaft of the motor via the gears, have maximum torque at stall of the motor. This means that the torque is decided by the motor stall torque and the gear ratio. The applied torque can be adjusted by regulating the air pressure to the motor. However, direct drive tools are frequently used where final tightening is determined by visual control and the operator simply releasing the trigger when the joint is tight enough.

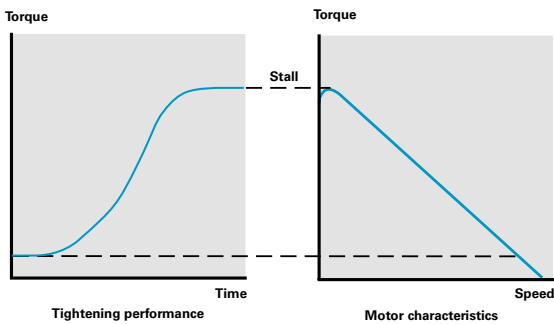

Figure 8. The screwdriver runs until the trigger is released or stalls when it reaches maximum torque

## 4. TEST METHODS

### Static measurement

The quality of the completed screw joint is tested statically. This means using a hand torque wrench to measure the torque after tightening. The torque wrench can be either a mechanical wrench with a torque scale or a wrench with a torque transducer that converts the applied force to an electrical signal to a torque read-out instrument. Measuring is done either by re-tightening the screw and reading the torque immediately the screw starts to turn or by measuring the peak torque when untightening. The loosening torque is usually approximately 75% of the tightening value.

The static torque measurement of a screw gives information on the torque rate and the general qualities of the joint. It is often also used for adjusting the screwdriver clutch to the correct tightening torque level. However, it does not give much information about the quality of the screwdriver. The reason is partly variation in the static friction in the joint that has to be overcome before the screw will turn and partly the relaxation in the joint that reduces the clamping force after tightening and decreases the turning torque.

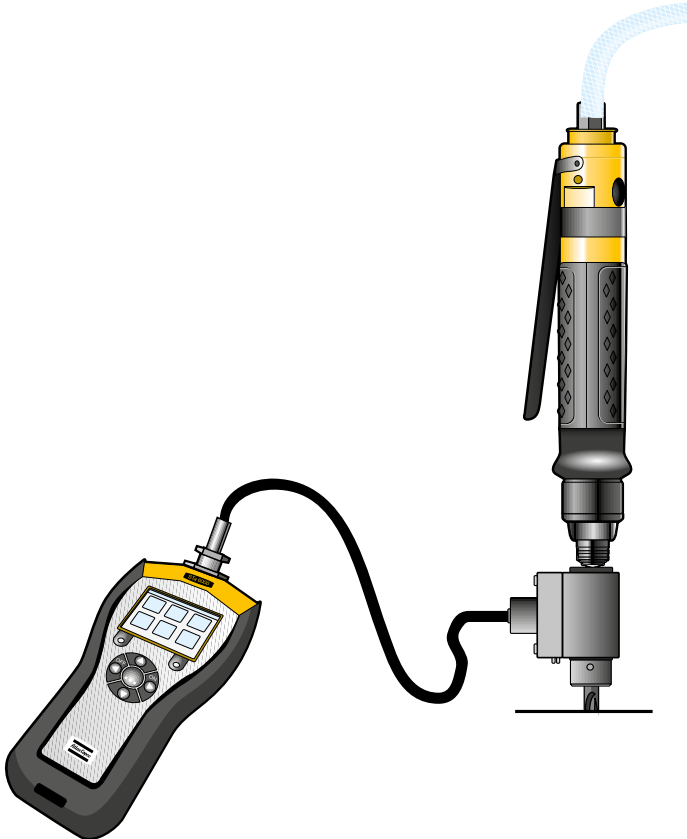

*Figure 9. Hand torque wrench with electronic read-out for static measurement.*

## Dynamic measurement

Accurate evaluation of screwdriver qualities requires dynamic torque measurements. This means using an in-line torque transducer to measure the torque during the actual tightening process. This method gives an accurate value of the applied torque without the influence of static friction and relaxation in the joint. Dynamic torque measurement on the actual joint provides the best value for clutch adjustment.

There are also in-line transducers with incorporated angle encoders that allow torque rate measurements to be done simultaneously for screw quality testing. Some sophisticated electric screwdriver systems have built-in transducers and angle encoders for continuous monitoring and/or control of the tightening process.



*Figure 10. In-line transducer with electronic read-out for dynamic measurement.*

## Screwdriver torque setting

Whatever the type of tool, the torque has to be measured before final adjustment of the applied torque. It is practical to preset the torque by means of a torque tester or an in-line transducer before the final adjustment on the actual joint for which it is intended. This can be made dynamically with the in-line equipment or by checking the screw statically with a torque wrench. Full verification of joint qualities involves measuring both the dynamic and the static torque.

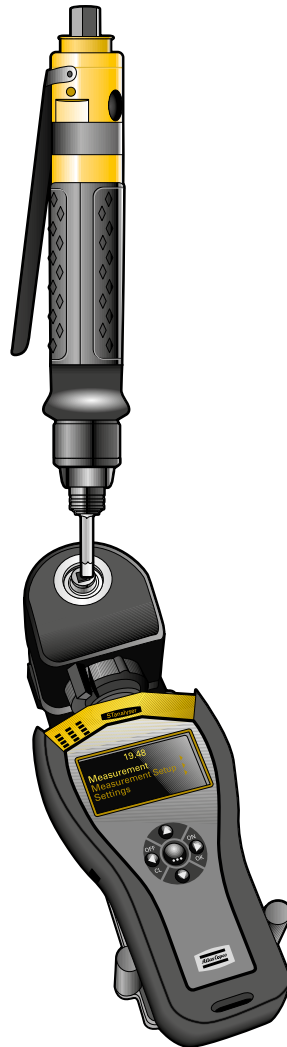

Figure 11. Torque tester with built-in test joint.



## 5. SCREWDRIVER SELECTION

We have touched upon the general aspects of various screwdriver qualities with regard to the torque control techniques available. Torque accuracy is not the only factor that depends on the type of clutch and quality of clutch selected. Torque reaction forces, noise, vibration, power bit wear, screw head damage and power consumption are further factors influenced by the selection of screwdriver clutch. Considerations that also arise are the power source and such physical aspects as speed and power, shape of tool, weight, dimensions and other design features.

### Power source

Screwdrivers available are powered by electric universal motors, by low voltage electric motors or by compressed air motors.



### Air motor

Air motors are the most powerful motors used in portable power tools in terms of weight and dimensions ratio. They are also sturdy, wear resistant and insensitive to overload, which makes them ideally suitable as power units in handheld power screwdrivers. The tools can be made small and easy to handle, they have a long service life and they can be operated and maintained without any risk of electric shock or burnout due to short-circuiting.

## Universal electric motor

Universal electric motors are not generally recommended for screwdrivers for industrial purposes because of the unfavourable power to weight ratio and the safety aspects. Some models of small screwdrivers are available for direct mains plug-in, which simplifies installation. However, it rarely compensates for their heavier and bulkier appearance and the electric safety risk.



Figure 12. Electric screwdriver for mains plug-in.

## Low voltage electric motor

Low voltage DC motor powered screwdrivers are quite common in small apparatus assembly as in the electronic industry, where low sound level and a clean environment free from pollution by exhaust air are essential. The tools are powered from the mains via a transformer and a control box with a rectifier at a voltage of 25-30 VDC. The controller also short-circuits the motor windings to bring the motor to standstill immediately upon clutch release, to avoid slipping.

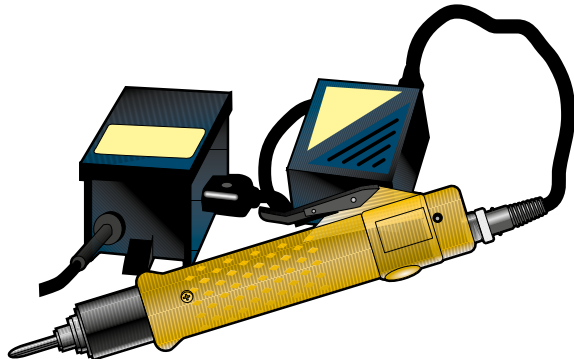

Figure 13. Low voltage screwdriver with transformer and controller.

## Battery powered motor

Battery tools were originally developed for carpenters and craftsmen whose prime requirement was mobility. However, air hoses and electric cables for power supply also present a problem in some industrial applications because of the risk of scratching finished surfaces or jamming when working inside closed compartments. This has led to changes in the mode of operation in many industries and many screws are now best tightened with a battery tool that allows freedom to move along a running production line without the inconvenience and safety risk of carrying hoses or cables.



Figure 14. Pistol-grip battery screwdriver.

At the same time, the growing demand for battery tools in the motor vehicle and other industries has brought increased demands on tightening control, reliability and service life. Consequently, battery screwdrivers today are available with torque shut-off clutches and in transducerized versions with variable error-proofing features, which make the tools highly suitable for both quality critical and safety critical applications.

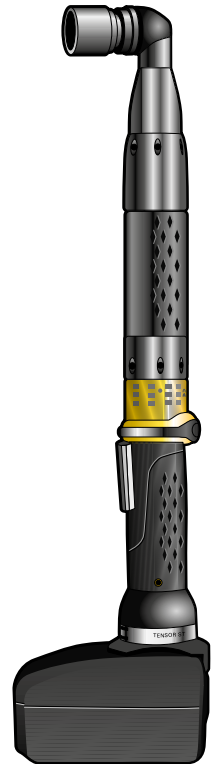

Figure 15. Battery angle nutrunner.

## Current controlled electric motor

There are also electric screwdrivers with specially built motors providing continuous control of voltage, current and frequency during the tightening process. These tools cover all assembly requirements for safety critical and quality critical applications.



Figure 16. Electric nutrunner with controller.

## 6. SHAPE OF TOOL

*Screwdrivers come in pistol grip models, straight configuration or with angle head. In most cases the selection is obvious – pistol models for horizontal operation, straight models for vertical operation and angle tools for access to awkwardly positioned joints. However, some practical hints are usually worth considering prior to decision.*

### Pistol grip screwdrivers

Pistol grip screwdrivers allow a firm grip of the tool with good support for the reaction forces from the tightening process. Pistol screwdrivers are therefore always recommended in the larger screw size range. For a torque above 8 Nm a support handle should be considered to reduce the wrist load on the operator. The pistol grip screwdriver is also the most suitable for self-drilling screws, sheet metal screws and wood screws that require quite a considerable amount of axial feeding force.

Pistol grip screwdrivers usually have a trigger for starting and stopping the tool. The trigger start is often combined with a push start function to ensure that the operation does not start until there is proper engagement between the power bit and the screw recess.

The reversing valve control should allow operation with the hand that holds the tool without having to change grip and preferably independent of whether the tool is operated with the left or the right hand.

The exhaust air from air-powered tools and cooling fans of electric tools should not be allowed to blow up dust or cool the hand of the operator. Many pistol screwdrivers offer possibilities to lead away the exhaust air for operator convenience.



*Figure 17. Shape of tool is of the utmost importance for operator comfort*

## Straight screwdrivers

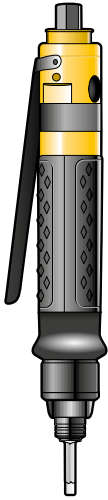

Figure 18. Straight screwdriver LUM 12 SR

Straight screwdrivers that have the motor, gearing, coupling and output shaft in line are convenient for use at fixed workstations for vertical operations. The tools are often suspended in balancers for easy access. Straight tools should not be used for torque above 4-5 Nm for male operators and 2-3 Nm for females because of the reaction torque, unless the screwdrivers are mounted in torque arms fixed to the workbench.

Straight screwdrivers have lever or button start, push start or combined lever and push start. Push start is the quickest type if the screws are well oriented before the operation starts. Lever start on air tools allows smooth starting to secure proper entry of thread and bit engagement. Combined lever and push start function is recommended where screws are picked up with the screwdriver bit prior to placing in the screw hole.

On lever operated screwdrivers the reversing control is usually of twist ring type that requires the use of the other hand. Push start tools are available with push button control for quick one-hand operation.

Low noise level and a clean working environment are often crucial issues on light assembly lines. Silencing and means to lead away exhaust from air powered screwdrivers are often decisive qualities.

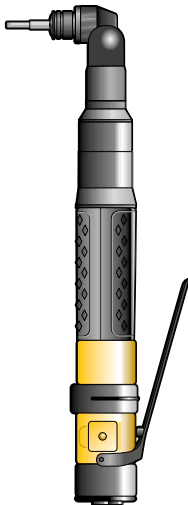

Figure 19. Angle head screwdriver LTV 19.

## Angle head screwdrivers

Angle screwdrivers are primarily used for accessibility reasons. They are basically built as straight tools with an angle head attachment. The lever arm housing the motor, gear and clutch makes reaction forces negligible for the lower screwdriver torque range. The angle screwdriver can also be the ideal solution for the higher torque range simply for the ability to counteract reaction forces. However, it limits the possibility of exerting manual force for feeding, an important consideration in cases such as cross recess head screws. For obvious reasons, angle screwdrivers are not equipped with push start function.

## 7. SELECTION OF PERFORMANCE DATA

As well as screw capacity and torque range, screwdrivers are also selected with regard to other performance values such as speed, power, energy consumption, noise and vibration emission. Speed and power are interconnected values essential for torque accuracy, productivity and operator convenience.

### Speed

Speed is naturally the prime factor in productivity but cannot be increased beyond certain limits. Difficulties in controlling screw entry and friction heat in threaded plastic are examples of practical problems of high speed tightening, but the most important reason to keep down rotary speed is the influence that speed has on torque accuracy. An idling speed of 900-1200 rpm is usually the most practical solution. Higher speeds are preferred for self-drilling screws and lower speeds should be used for driving screws in soft materials such as plastics to avoid overheating the material.

Speed also influences operator exposure to reaction forces. On hard joints most of the reaction torque is absorbed by the inertia of the high-speed tool, whereas the tightening process with a low-speed tool will seem softer but with a greater jerk on the hand of the operator. It follows that higher speeds are advantageous from an ergonomic point of view but require a quick action clutch to avoid excessively increasing the torque mean shift.

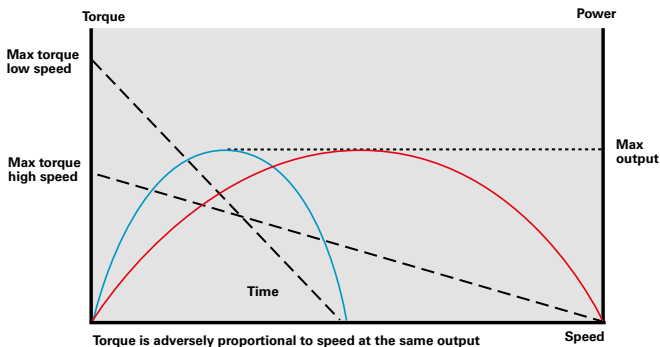

Figure 20. Output to speed diagram for different screwdriver models.

## Power

Being a function of speed and torque, it follows that the motor size required is larger for a high speed tool than for a low speed model at the same torque capacity. From a durability point of view it is better to select a tool with a larger motor size and a capacity well above the target torque than a small tool at the limit of its capacity, as this might lead to clutch failure, especially if the supply air pressure drops below the nominal value.

A powerful tool is also recommended for tightening of soft joints, thread forming screws and wood screws, as the resistance in the threads reduces the speed and lengthens tightening times.

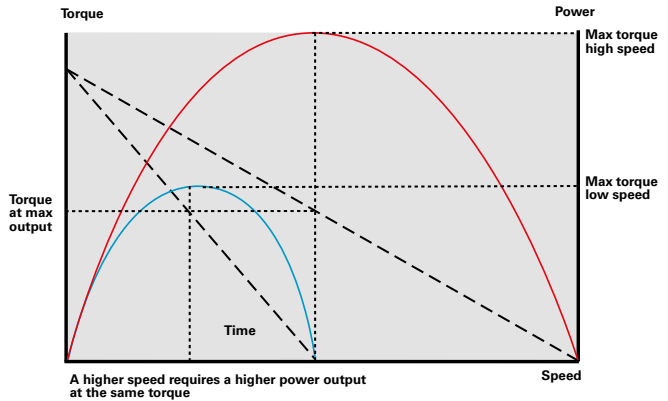

Figure 21. Output to speed diagram for different screwdriver models.



## 8. SELECT THE SCREWDRIVER TO SUIT THE JOINT

To utilize fully the high performance of a high quality screwdriver, it is important to know the demands made on the screwdriver by different screw joints. Here are some examples that will help you select the kind of screwdriver you require.

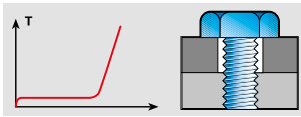

Figure 22

### Machine screw – Hard joint

Low resistance to turning until the screw head reaches its seating, after which resistance rapidly increases. For rapid operation with moderate torque accuracy choose a high speed tool. For close torque tolerances or when the quality of thread is uneven, choose a lower speed tool. This is also recommended for brittle material. Most suitable clutch is shut-off type. Alternative choice slip type.

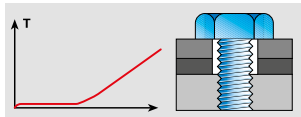

Figure 23

### Machine screw – Soft joint

Low resistance to turning until the screw head reaches its seatings, after which resistance slowly increases. A lower speed than used for the rigid joint utilizes the torque capacity of the tool. For more rapid tightening choose a larger size tool with a higher speed. Most suitable clutches: Shut-off type. Slip type possible.

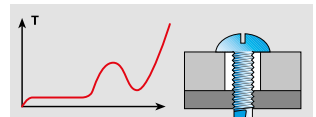

Figure 24

### Self-drilling screw

The turning resistance gradually increases during drilling and thread cutting, but more slowly than with self-threading screws. Choose a tool with speed over 1000 rpm. Slip type clutch is generally suitable but for thin sheet choose shut-off.

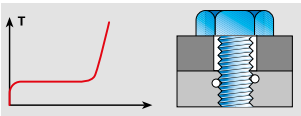

Figure 25

### Machine screw – locking element in thread

Relatively high resistance to turning before screw head reaches its seating, after which resistance rapidly increases. Choose a tool with high torque from the lower speed range. If rapid driving is required choose a larger tool with a higher speed. Suitable clutches: Slip type and shut-off.

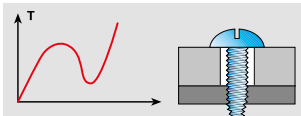

Figure 26

### Thread producing screw

The turning resistance gradually increases as the screw is producing the thread and reaches a maximum just before the entire hole is threaded. Choose a tool within speed range 800 to 1300 rpm. Slip type clutches are generally suitable, but for thin sheet choose shut-off type.

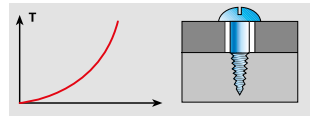

Figure 27

### Wood screw

The turning resistance gradually builds up as the screw is being driven and increases rapidly when the screw head reaches its seating. The process varies considerably with the degree of predrilling, different types of wood and sizes of screw. Choose a low speed tool, 400 to 800 rpm. Suitable clutches: Slip type and direct drive.

## 9. SCREWDRIVER ACCESSORIES

*Screwdriver accessories include a number of essential items as well as optional equipment to extend and improve the field of operation. Some useful items are:*

### Screwdriver bits

Good quality bits are essential for satisfactory screwdriver performance. Bit shape correctly fitting the screw head recess and correct hardness are crucial for bit life and minimum damage to screws. Magnetic bit holders facilitate positioning of screws but the insert bit must be kept clean from iron chips to avoid misengagement with the screw head.

Extra-hard bits should be used for sheet metal screws and other hardened screw types.

Finders are extra equipment and must be used for slotted screws unless there are fixtures with bushings to guide the bit.

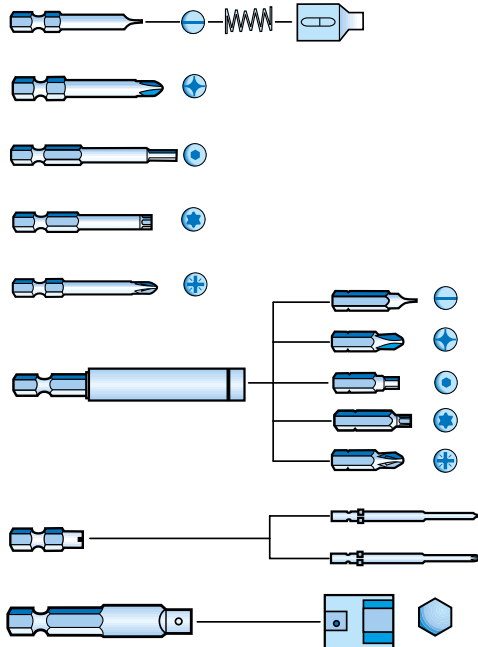







Figure 28

## Survey of screwheads

Symbol	Description	Size	Application	Comments
	Slotted	Slot width 0.25-2.5	Wood screw Sheet metal screw Machine threaded screw	Inexpensive. Relatively difficult to fit (the slot is ruined). Requires a finder for guidance.
	Phillips (cross recess type H)	00-3	Wood screw Sheet metal screw Board screw Machine threaded screw	Inexpensive. Requires a certain axial force when fitted. Note: Use the right bits when mounting. Do not confuse with Pozidriv bits.
	Pozidriv® (cross recess type Z)	1-3 P2D 1-3 S0V	Wood screw Sheet metal screw	Somewhat expensive. Easy to fit. Only requires about 30% of the axial force needed with Phillips screws. Note: Use the right bits when mounting. Do not confuse with Phillips bits.
	Hexagon	7-16 mm	Machine threaded screw Thread forming screw Self drilling screw	Suitable for higher torques. Usually for screws M4 and upwards. Easy to fit. Somewhat difficult to enter.
	Internal hexagon Allen head	Hex size 2-8 mm	Machine threaded screw	Requires low axial force. Difficult to enter. Available from M3 and upwards.
	Torx®	T6-T40	Machine threaded screw Sheet metal screw	Relatively expensive. Easy to fit. Saves bits. Easy to enter. Low axial forces needed. Can transmit relatively high torques. Larger screws also available with external grip.

A number of screws have been developed for special applications, for example:

	Torq-Set®	TSO-0 TSO-10	Special screw for the air industry.	Expensive. Easy to dismantle.
---	-----------	-----------------	--	-------------------------------

Table 4

## Balancers and torque arms

Screwdrivers are comparatively small and lightweight tools but when the small effort of lifting and lowering the screwdriver in the course of the tightening operation cycle is repeated maybe several hundred times per hour, even the light weight of a screwdriver becomes a burden to the operator.

The same applies to the reaction torque from a screw tightening operation. Balancers to reduce the load on the operator and/or torque arms to limit the strain from reaction forces should always be considered in repetitive assembly work.

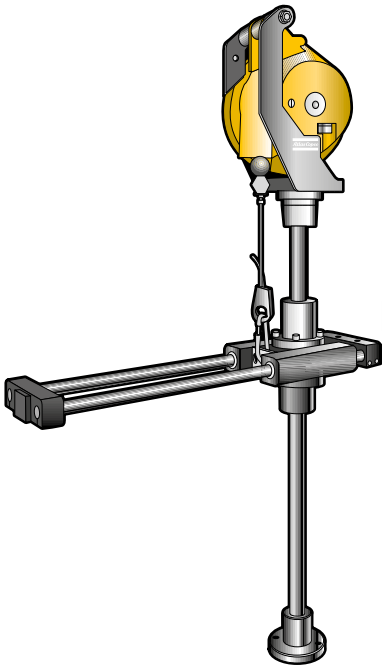

Figure 29. SML torque arm

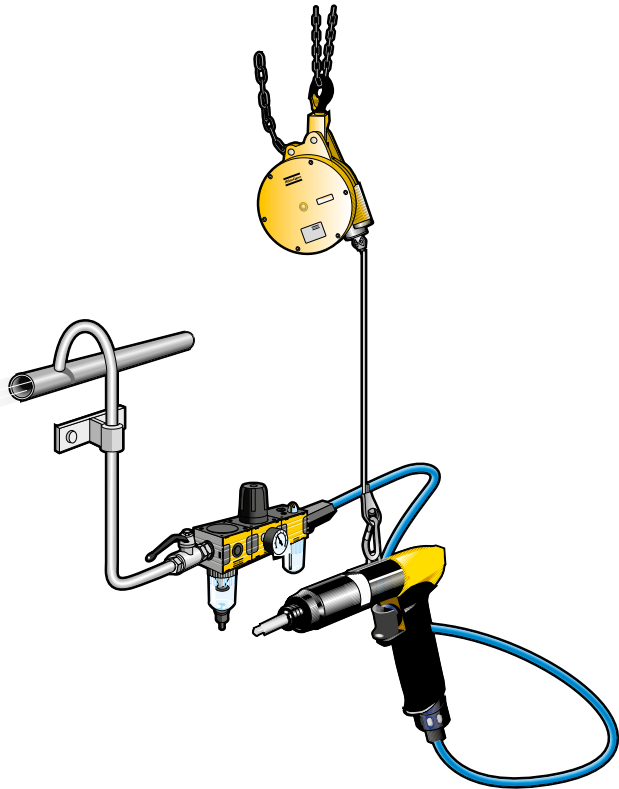

Figure 30. Screwdriver with WP balancer

## ESD approval

All electronic components are more or less sensitive to ESD (Electrostatic Discharge). All materials and the human body itself can accumulate an electrostatic charge that might discharge to any other object of differing polarity, and if the object concerned incorporates, for instance, a semiconductor the device might have a functional breakdown. Screwdrivers are extensively used in the assembly of electronic devices and are therefore critical items from an ESD point of view.

The risk that electrostatic charges will remain on the surface of the tool and discharge to a critical object is eliminated by making plastic components such as insulating covers and triggers on tools out of a dissipative or conductive compound and connecting the screwdriver body electrically to ground.

When you assemble electronic devices, make sure that you use ESD approved screwdrivers.

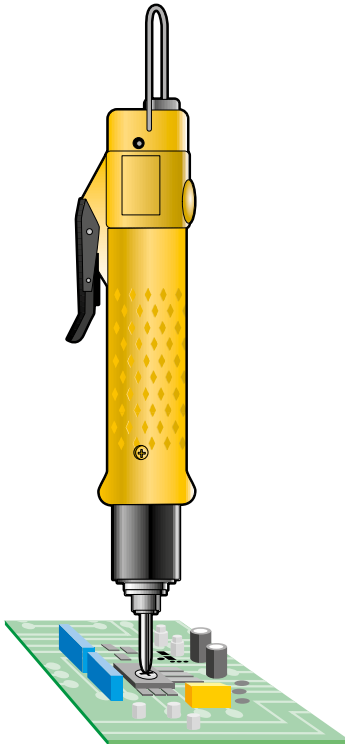

*Figure 31. When you assemble electronic devices, make sure that you use ESD approved screwdrivers.*

## 10. INSTALLATION

The performance of the operator-tool combination is no more efficient than whichever is the weaker member of this team. A good working position is necessary for the operator to be able to utilise the capacity of the tool. Proper tool installation is also essential to get as much productivity and service life out of the tool as are paid for.

### Air-powered screwdrivers

An air powered screwdriver consumes between 3 and 15 litres of compressed air per second. Wrongly dimensioned or leaking airline accessories will not allow a sufficient air supply to the air motor, which means power drop, lower production and increased production costs.

The airline installation at an assembly station with screwdrivers should include a ball valve, a filter, a pressure regulator, an open flow hose coupling (claw or ErgoQuick), a PVC hose of max. 5 m length or a spiral hose and a quick coupling (preferably ErgoQuick) to the tool inlet. Modern screwdrivers are lubrication free, which means that no in-line lubricator is necessary.

There is specially ESD approved PVC hose for air supply in ESD sensitive environments.

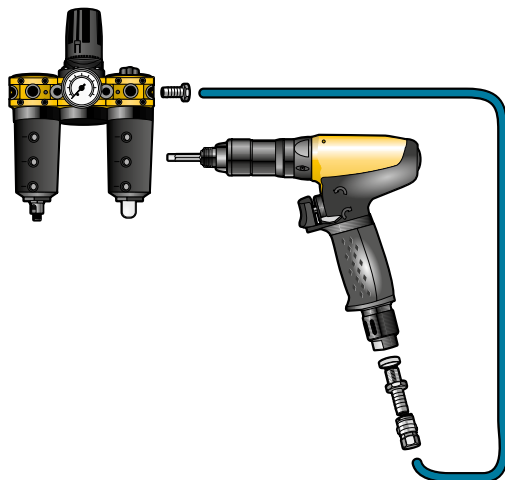
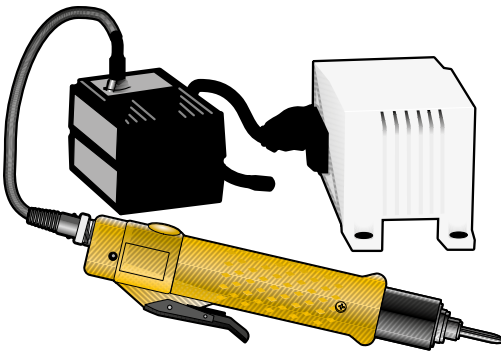

Figure 32. Installation of air-powered screwdrivers

## Electric screwdrivers

The installation of an assembly station with low-voltage electric screwdrivers consists of a transformer with cable for mains plug-in, a rectifier and controller built into a control box, a combined power and signal cable and the tool. Alternatively a combined transformer/controller can be used to simplify installation but this is somewhat more expensive, especially if it breaks down. With a bigger transformer a power supply network can be built to supply several tools simultaneously.



*Figure 33. In ESD protected areas make sure that all items are ESD approved.*

Electric installations also require proper dimensioning. A 3m cable between control box and tool is included as standard equipment with the tool. Optional extension cables can increase the distance up to maximum 8m without causing excessive power losses. A spiral cable is also available as an extra accessory.

# 11. SCREWDRIVER ECONOMICS

In deciding which power screwdriver to choose for an industrial assembly operation it is essential to consider not only the price of the tool but the cost of the whole process, including rejects, remedial work due to bad quality tightening and loss of goodwill. And in this process the tool investment cost is usually of minor importance. In most cases the labour cost is the dominant part of the cost calculation.

With handheld tools it is the combined performance of the operator and the power tool that decides the productivity. How much a screwdriver can produce is limited by the power output of the tool. But the tool also puts a limitation to how fast and accurately the operator can work. In addition to the capacity of the screwdriver, factors such as the quality of the tool in terms of torque accuracy and how the handling of the tool affects the operator by torque reaction, noise and vibration, weight, shape, physical load etc. are also decisive for the economics of tightening.

Naturally, the quality of the screwdriver with regard to service life and maintenance cost must also be included in the total cost calculation.

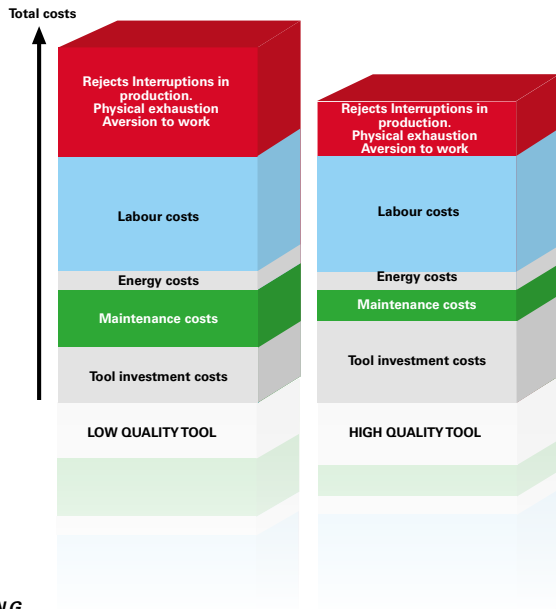

Figure 34



## 12. TROUBLE SHOOTING CHART

The quality of a screw joint is the result of the combination of joint characteristics, screwdriver performance and the operator influence. When problems occur it is not always obvious what causes the deviation in joint behaviour. The following table is intended to give a quick reference to possible causes and the relevant suggestion of actions to cope with a number of typical problems in tightening of threaded fasteners.

Table 5

Symptom	Cause	Solution
Insufficient clamping – screw works loose	Too low tightening torque adjustment	Check tightening specifications, adjust
	Poor torque accuracy	Reconsider tool selection with regard to clutch type, speed and reliability.
	Supply air pressure drop	Check pressure at tool idling
	Insufficient screw lubrication	Adjust lubricating specifications
	Joint relaxation	Try slip clutch or use screws with flanged head or washer
	Short clamping length	Check possible change of design or introduce spring washer
	Excess torque adjustment	Check tightening specifications, adjust
Cross threading	Poor screw quality/ damaged thread	Make quality inspection, sort out failures
	Too high screw entering speed	Select screwdriver with smooth start (lever/button throttle)
	Poor tool balance	Check if tool (handle type, weight, balance etc.) is right for the job
Threads stripping	Excess speed	Select lower speed model
	Varying screw friction	Specify surface treatment
	Excess hole diameter for thread forming screws	Adjust specifications
	Insufficient thread engagement	Increase screw length or threaded material thickness
	Friction below screw head too low	Increase screw head diameter or introduce friction flange (for plastic material)
Tool does not back up the screw after tightening	Too high tightening speed	Select lower speed model or consider slip clutch screwdriver
	Extremely soft joint with high resting friction	Consider slip clutch screwdriver or check with Atlas Copco for alternative

# POCKET GUIDES FROM ATLAS COPCO INDUSTRIAL TECHNIQUE

Title	Ordering No.
Air line distribution	9833 1266 01
Air motors	9833 9067 01
Cable management	9833 1640 01
Drilling with handheld machines	9833 8554 01
Error proofed production	9833 1437 01
Grinding	9833 8641 01
LEAN	9853 8215 01
Percussive tools	9833 1003 01
PowerTool Ergonomics (book)	9833 1162 01
Pulse tools	9833 1225 01
Riveting technique	9833 1124 01
Screwdriving	9833 1007 01
Statistical analysis technique	9833 8637 01
Testing and calibration in assembly technology	9833 1720 01
The art of ergonomics	9833 8587 01
Tightening technique	9833 8648 01
Vibrations in grinders	9833 9017 01
Vibration exposure assessment for power tools	9833 1508 01



*COMMITTED TO SUSTAINABLE PRODUCTIVITY*

[www.atlascopco.com](http://www.atlascopco.com)

