



Atlas Copeco



The world of Sockets and Bits

Your handbook



A wide range of sockets and bits from Saltus

This handbook has been designed to help you choose the right **sockets and bits** from Saltus, for performance, safety, and total cost of ownership (TCO). We have organized the sections according to options to consider – from our ROTACTION sockets and our isolated sockets, to customized sockets, Hold and Drive solutions, best practices and standards. Throughout this guide, you will be introduced to new and familiar scenarios and solutions that expand on why it's best to always use sockets of a higher quality.

THIS DOCUMENT IS NOT A USER MANUAL OR SAFETY GUIDE. FOR ANY QUESTIONS ON THE USE OR OPERATION OF SPECIFIC ATLAS COPCO TOOLS PLEASE CONSULT THE APPROPRIATE USER MANUAL. FOR ANY QUESTIONS ON THE USE OR OPERATION OF S SALTUS SOCKETS AND BITS PLEASE CONSULT YOUR LOCAL ATLAS COPCO SALES REPRESENTATIVE.

Contents

01 Sockets and bits: critical to fastening.....	5
1.1 Safety and total cost of ownership (TCO).....	6
02 Hand-operated vs.machine-operated sockets.....	7
2.1 The difference.....	7
03 Machine-operated sockets and bits.....	10
3.1 Use of the most suitable material	10
3.2 Tolerances	10
3.3 Heat treatment	10
3.4 Quality and cost.....	11
3.5 Head-to-head comparison.....	11
3.6 4-panel example.....	12
04 Sockets for increased productivity	14
4.1 ROTACTION sockets	16
4.2 Ergonomics and tightening.....	22
05 Tightening on live EV batteries	25
5.1 Isolated and insulated solutions	25
5.2 Product range: isolated socket solutions	26
5.3 Tested	33
5.4 Insulated tool covers	34
5.5 EV battery assembly.....	36
06 Customized sockets and bits.....	40
6.1 Customizable factors.....	40

01

Sockets and bits: critical to fastening

07 Sockets and bits: standard Saltus portfolio.....	48
7.1 Sockets: output drives	49
7.2 Sockets: optional features.....	51
7.3 Bit sockets.....	52
7.4 Nut setters.....	53
7.5 Stud setters	53
7.6 Extensions	54
7.7 Adapters and QCAs	55
08 Bits and bit holders	56
8.1 Bits.....	56
8.2 Bit holders	61
09 Hold and Drive solutions	64
9.1 Examples and principle.....	64
9.2 Sockets, screw holders, bit holders and bits for HAD angle head power tools	66
9.3 Reaction-free HAD power tools	78
9.4 Reaction torque	82
10 Proper use of sockets and bits.....	84
10.1 Use sockets and bits.....	84
10.2 Side forces on the sockets and bits.....	84
10.3 Misalignment of the socket/bits.....	85
10.4 Gripping the screw/bolt.....	85
11 Best practices	86
11.1 Scenarios.....	86
Appendix	92

Manufacturing companies invest considerable resources in high-quality power tools and controllers. This is to ensure that fasteners are tightened correctly. But there are small yet critical components that are often overlooked in the evaluation process. They sit between the machine-operated tool and the fastener. Meet sockets and bits. Although they are treated as an operating expense (OPEX), sockets and bits play an important role in the tightening process, safety and long-term costs.

High-quality durable sockets and bits cut down on operating expenses over time. That's not all. Ergonomic and safe sockets improve productivity. However, even with high-quality sockets, it is important to be aware of the right practices for extending socket life. For example, taking care to apply the correct torque and avoiding misalignments/side forces.

This handbook has been designed to help you pick the right sockets for your requirements, while bringing your attention to the importance of safety. You will also find recommendations for the proper use of sockets and bits that will help maximize socket life.



NOTE: Throughout this booklet, the term sockets will be used as a catch-all for sockets and bits, bit sockets, extensions and accessories, while often also referring to just sockets. Refer to [Section 8](#) for more details on the types of sockets and accessories available.

1.1 Safety and total cost of ownership (TCO)

To help in your search for the right sockets and bits, we have identified five levels you should consider when assessing for quality, operator safety and low TCO. Let's dive deeper into each category.

Five steps to low TCO



1 Hand-operated sockets



2 Machine-operated sockets



3 ROTACTION sockets



4 Isolated sockets



5 Customized sockets

Level 1	<p>Hand-operated sockets</p> <p>Available in hardware stores, these sockets should not be used for power tools.</p>
Level 2	<p>Machine-operated sockets</p> <p>These robust sockets are meant to be used with power tools. They are processed with adequate tolerances, suitable material and correct hardening for durability.</p>
Level 3	<p>ROTACTION sockets and bits for improved operations</p> <p>A combination of freely rotating sleeves and developed covers for "tool-to-socket" and "extension-to-socket" connections that significantly improve operator safety.</p>
Level 4	<p>Isolated sockets and Quick Change Adapters</p> <p>They provide galvanic isolation in the axial direction which breaks electrical conductivity. Furthermore they insulate in the radial direction by freely rotating sleeves. The isolated Quick Change Adapters (QCAs) have been developed as a modular system, to be used in combination with a major part of our standard ROTACTION range of sockets and bits.</p>
Level 5	<p>Customized sockets</p> <p>Sockets can be customized for specific requirements such as length and outer diameter adjustments that are not part of our standard offering. Saltus designs these special sockets on request.</p>

02

Hand-operated sockets vs. machine-operated sockets

Machine-operated sockets are designed for use with electric or pneumatic power tools. They can be used with hand-operated tools as well, but hand-operated sockets should **never** be used with power tools since this would cause the sockets to split or shatter.



Hand-operated sockets

Sockets that are used for hand-operated mechanical wrenches, ratchets and spanners.



Machine-operated sockets

Sockets that are used with machine-operated industrial power tools like electric or pneumatic power tools.

REMEMBER: Pair black and yellow sockets with black tools



2.1 The difference

	Hand-operated sockets	Machine-operated sockets
Appearance	Chrome-plated	Black-oxidized/with yellow ROTACTION sleeves
Material	Alloy steel, typically chrome vanadium	High-grade alloy steel, typically chrome molybdenum
Wall	Relatively thinner walls	Thicker walls
Use	Used with hand tools	Designed to work with power tools
Price	Inexpensive	Relatively expensive, but lasts longer
Durability	Can last if limited to simple tasks	High performance, durable
Connection to tool	Easily removable, often with ball retainer	Pin & O-ring; has a groove for Pin & O-ring
Torque	For lower forces	Withstands higher forces
Hardness	In general, lower hardness (HRC) for all these product types	In general, higher hardness (HRC). The hardness is dependent on the product and material.

How to connect sockets to power tools

Sockets used on power tools should have a fixed connection to the tool. The reason is that if the socket loosens from the power tool during operation, it could lead to injuries. The image below shows the three most common styles of output drive on tools today.

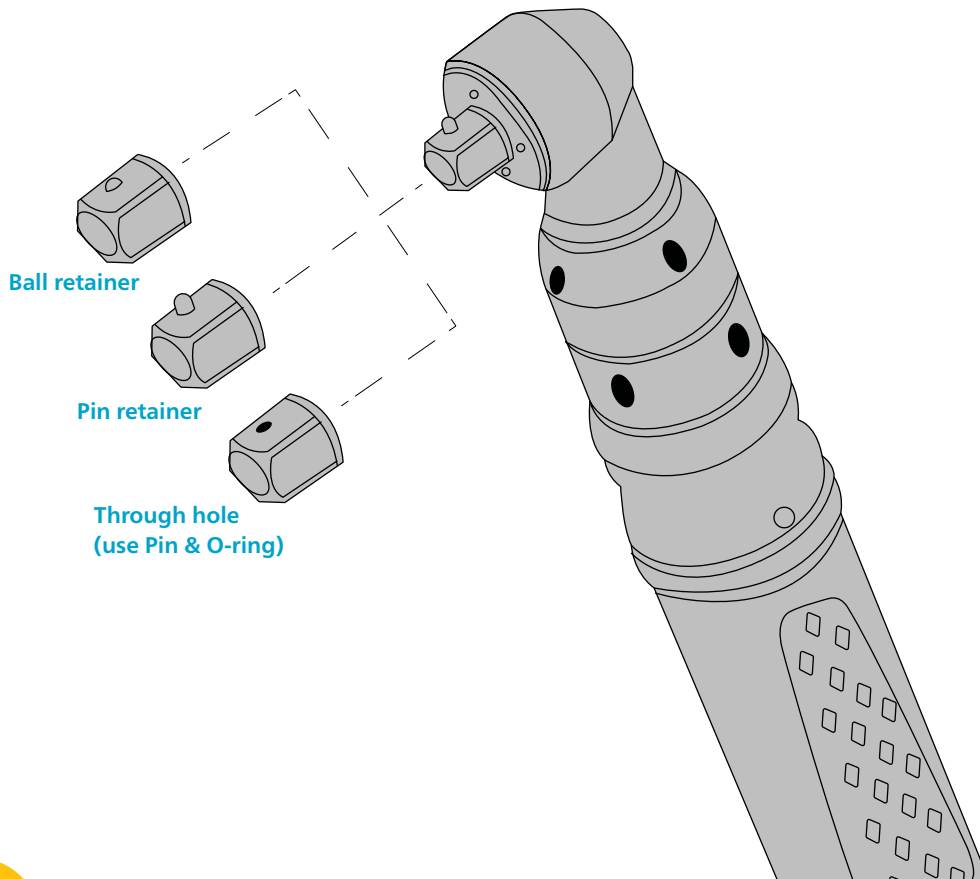

DID YOU KNOW?

The groove and through hole found on machine-operated sockets are meant for a Pin and O-ring. It securely locks the connection to power tools which prevents the socket from loosening as a result of the vibrations generated by the power tool.



There are **four common ways** to connect a socket to a power tool, an adapter, or an extension:

1. Ball retainer

Used on male square drives to easily disassemble the socket.
NOTE: This connection is not 100% secure.

- The maximum weight which can be attached to a 3/8" square drive with ball retainer, must not exceed 0.5 kg.
- The maximum weight which can be attached to a 1/2" square drive with ball retainer, must not exceed 1 kg.

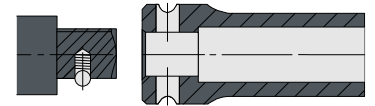

2. Pin retainer

On male square drives. To disassemble the socket, the pin must be pushed down.

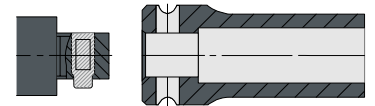

3. Through hole (use Pin & O-ring)

On male square drives with through hole: mount the socket with a Pin and O-ring.

ROTACTION sockets up to 1/2" square cannot be used on male square drives with a through hole.

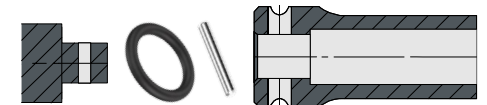

4. Removable threaded pin

When ROTACTION sockets are used on square drives 3/4" and larger, a removable threaded pin must be used, since the square drive has a through hole.

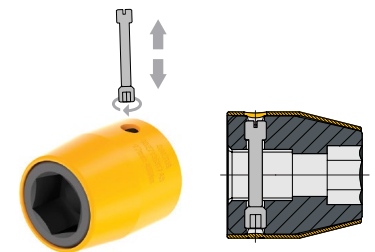

Clip retainer

Although you have the option of using a clip retainer (as shown here to the right) we would not recommend it.



NOTE:

- Tools with drive shaft sizes 1/4" - 1/2" are almost always delivered with a spring-loaded pin.
- For tools with drive shaft sized 3/4" and higher, the shaft is just delivered with a "hole" so you will need to use a Pin and O-ring.
- For some applications the customer requires an adapter or extension (used between the power tool and the socket) to extend the reach of a tool for the purpose of loosening or tightening fasteners.

03

Machine-operated sockets and bits

Machine-operated sockets are built for use with power tools (electric, hydraulic, or pneumatic). The right material, tolerances in line with ISO 1174/ISO 691 (see Appendix C) and state-of-the-art heat treatment, are critical to the making of high-quality sockets that deliver the right torque and clamping force.

3.1 Use of the most suitable material

High-grade alloy steel is used in the making of industrial bits and sockets. Steel alloy with a high carbon content gives a fastener drive a high level of hardness and strength. The alloyed, quenched and tempered steels are versatile and are mainly used in machine, automobile and vehicle construction. High levels of strength and high toughness mean the sockets can last longer and withstand greater stress

3.2 Tolerances

Saltus sockets are produced according to ISO standards, specifically, ISO 1174/ISO 691 (see Appendix C). This means an optimal fit between the bolt head and the socket. It also ensures a tighter fit between the square drive of the power tool and the socket, resulting in less wear for the socket and the power tool. Practical use demonstrates that high quality sockets reduce socket consumption considerably (refer to Section 3.4).

3.3 Heat treatment

The right heat treatment is critical to making sockets that are strong and durable. Heat treatment is a controlled process that alters the micro-structure of metals and alloys, extending the working life of sockets.

Saltus sockets and bits are heated in electrically-heated furnaces. The process is monitored and controlled by a computerized system, which handles all furnace sequences.

Quenching takes place in different ways such as through the use of tempered oil. We also undertake induction heating which allows for partial hardening.



3.4 Quality and cost

In this comparison with a competing supplier of industrial sockets and bits, a simple calculation demonstrates the potential savings resulting from the use of high-quality sockets. A similar comparison for bit sockets is laid out in a 4-panel example in [Section 3.6](#).



Justification by comparison

	Competitor	Saltus
Cost per bit socket	\$95.00	\$52.68
Failure rate (days between failure)*	1.5	4
Projected bit socket consumption in 1yr**	147	55
Total investment	\$13,965	\$2,897
ROI per year	\$11,068	
Payback period (months)	2.5	

* Projected failure rate for Saltus

** 220 working days per year

3.5 Head-to-head comparison

When it comes to the replacement of sockets, tests have shown a big potential for savings. Local comparison tests can uncover the savings potential for a customer. The 4-panel example we use for internal evaluation reveals the savings potential through four stages: problem description and analysis, justification for implementing the solution, solution and implementation plan, and validation post implementation.

The calculation

1. Test the sockets (a good example is sockets used for tightening wheels with a wheel nutrunner) in a defined area with one side equipped with Saltus sockets and the other equipped with existing sockets.
2. Compare the frequency of changes between the two. If the ratio is 3:1, then divide your yearly consumption by three, and multiply the number of sockets with the new average socket price.
3. Compare the new theoretical price with the real yearly cost of purchasing sockets and evaluate the savings.

3.6 4-panel example

The following 4-panel example is a head-to-head between Saltus and a competing supplier of industrial sockets. It is based on an actual evaluation for assembly of a cylinder head at a client's premises.

Problem description and analysis

- Competitor's Torx® bit socket for installing the cylinder head fails in 1-2 days
- During the test three years, customer has gone through nearly 450 bit sockets
- At \$95 per bit socket, over \$42,750 has been spent to date



Solution and implementation plan

- Purchase Saltus standard Torx® bit socket instead of the competitor's
- Remaining competitor inventory to be depleted before implementing Saltus on line
- Inventory of bit sockets to be ordered. Stock levels to be determined based on final usage



Justification for the solution

	Competitor	Saltus
Cost per bit socket	\$95.00	\$52.68
Failure rate (days between failure)*	1.5	4
Projected bit socket consumption in 1yr**	147	55
Total investment	\$13,965	\$2,897
ROI per year	\$11,068	
Payback period (months)	2.5	

* Projected failure rate for Saltus

**220 working days per year

Validation post-implementation

- Through testing, the Saltus Torx® bit socket lasted 7 days on average
- Order for 16 bit sockets received
- Working with Engineering to identify and test similar solutions at the other problem stations

	Competitor	Saltus
Cost per bit	\$95.00	\$52.68
Failure rate (days between failure)*	1.5	7
Projected bit socket consumption in 1yr**	147	31
Total investment	\$13,965	\$1,633
ROI per year	\$12,332	
Payback period (months)	1.4	

* Projected failure rate for Saltus

**220 working days per year

Atlas Copco can support you in preparing 4-panels for use in internal discussions and evaluations. For more information, contact your local Atlas Copco sales representative.

04

Sockets for increased productivity

Today, we see an increasing focus on "Safety First" at our customers' plants. In response to the need for improving operator safety, we have ramped up our ROTACTION offering.



4.1 ROTACTION sockets

What is ROTACTION? This trendsetting concept from Saltus is a combination of **freely rotating sleeves** and covers for "tool-to-socket" and "extension-to-socket" connections that significantly improves operator safety.

Freely rotating sleeves

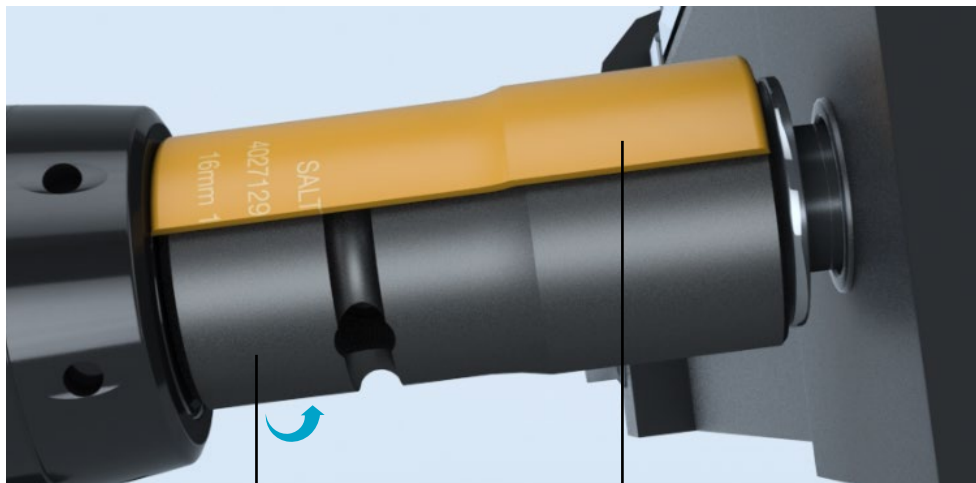

The black metal socket rotates on the inside

The yellow ROTACTION sleeve is freely rotating and stays perfectly still when the black socket is rotating

The ROTACTION range includes:

- Numerous sockets, bits, bit sockets, QCAs and nut setters with freely rotating protection sleeves
- Various extensions with rotating protection sleeves
- Socket covers to bridge gaps between extension and socket
- Tool covers to close the gap between tools and sockets, bits or extensions

In addition to a wide range of standard ROTACTION products, customized solutions can be developed.

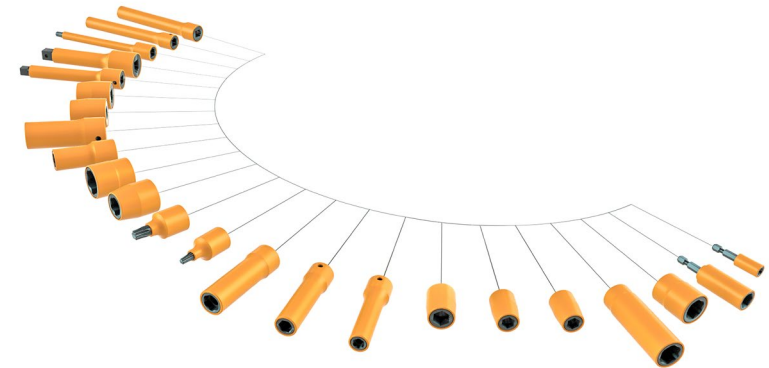

Examples of tool covers



Example of a socket cover

For more information about our ROTACTION range refer to Saltus catalog [Sockets and Bits for Industrial Power Tools](#)



ROTACTION sockets, in combination with tool covers and socket covers, provide enhanced control over the tool.

CHECK OUT THE VIDEO

4.1.1 ROTACTION best practices

Here are a few general recommendations. Select the best combination for your application.

- Check the reach: it should be as long as necessary, but as short as possible.
- It's better to use a longer socket than an extension and a socket.

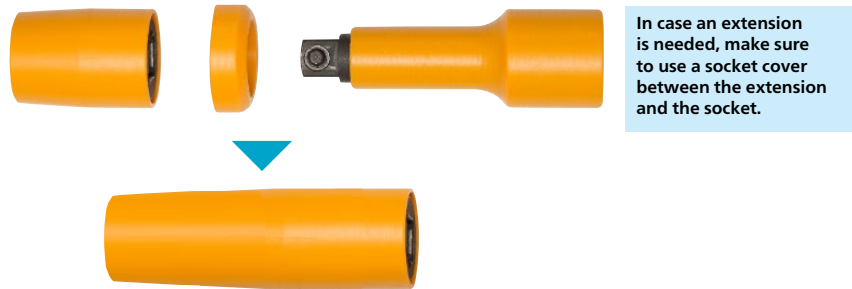

- If you need to change your sockets/bits regularly, you can use QCAs.



Extensions with a ball retainer



NOTE:

- Ball retainers make it easy to disassemble the socket. However such a connection is not 100% secure.
- The maximum weight which can be attached to a 3/8" square drive with ball retainer must not exceed 0.5 kg.
- The maximum weight which can be attached to a 1/2" square drive with ball retainer must not exceed 1 kg.

- Bits can be used with ROTACTION bit holders in different lengths



- Bit sockets are also available in ROTACTION



- Use ROTACTION tool covers
 - Tool covers are available for a large number of Atlas Copco power tools
 - Contact your nearest Atlas Copco sales representative in if cannot find the tool covers

User recommendations

- Sockets and bits must be checked daily before use, for damage, cracks and wear.
- Sockets and bits which are damaged, cracked or broken must not be used and should be replaced immediately.
- Sockets and bits which show clear signs of wear (for example: rounded square drives, rounded hexagonal profiles, etc.) must be replaced as soon as possible.
- ROTACTION sockets with damaged, cracked or broken sleeves must not be used and should be replaced immediately with a new ROTACTION socket.

For most ROTACTION sockets, sleeves can be exchanged with spare sleeves, but special instructions for assembly and disassembly of ROTACTION sleeves need to be followed in order to properly mount the sleeve.

The ROTACTION system:

1 integrated fix for 3 common risks

Below we describe three possible risk scenarios when performing tightening operations without a complete ROTACTION system. On the right side we present the solutions. It is important to use all three solutions.

SCENARIO 1: RISKS

Entanglement hazard in the gap between the tool and socket/extension



When using sockets on power tools, you will see a gap between the tool and the socket or extension. The weight of the tool is enough to close the gap, when you place the tool on the fastener for tightening. This increases the risk of entanglement.

This image shows the gap on a tool with a square drive.

Use tool cover to cover the gap between tool and socket/extension



To reduce the risk of entanglement in the gap between the tool and the ROTACTION socket or extension, you need a tool cover.

SCENARIO 1: SOLUTIONS

SCENARIO 2: RISKS

Entanglement hazard with sockets/extensions without freely rotating sleeves



Hands and objects can get entangled in the rotating drive or socket.

Use ROTACTION sockets/extensions with freely rotating sleeves



With the freely rotating sleeve, there is a lower risk of entanglement in the socket.

SCENARIO 2: SOLUTIONS

SCENARIO 3: RISKS

Entanglement hazard between extension and socket



In addition to the gap between the tool and the extension as described in Scenario 2, there is also a gap between the extension and the socket.

Use a socket cover to cover the gap between the extension and socket



You need a socket cover to minimize the risk of entanglement in the gap between the ROTACTION extension and the ROTACTION socket.

SCENARIO 3: SOLUTIONS

The integrated solution

- Use a ROTACTION socket or bit and a ROTACTION extension to minimize the risk of entanglement
- Use a tool cover to cover the gap between tool and socket
- The gap between the extension and the socket must also be covered. There is a range of socket covers for different sizes of extensions, e.g., 1/4", 3/8" and 1/2" square drive.

SCENARIO 1 + 2 + 3

Any or all of the three scenarios described in the previous pages, could occur at any time. The integrated ROTACTION system is our recommended solution for maximum protection.

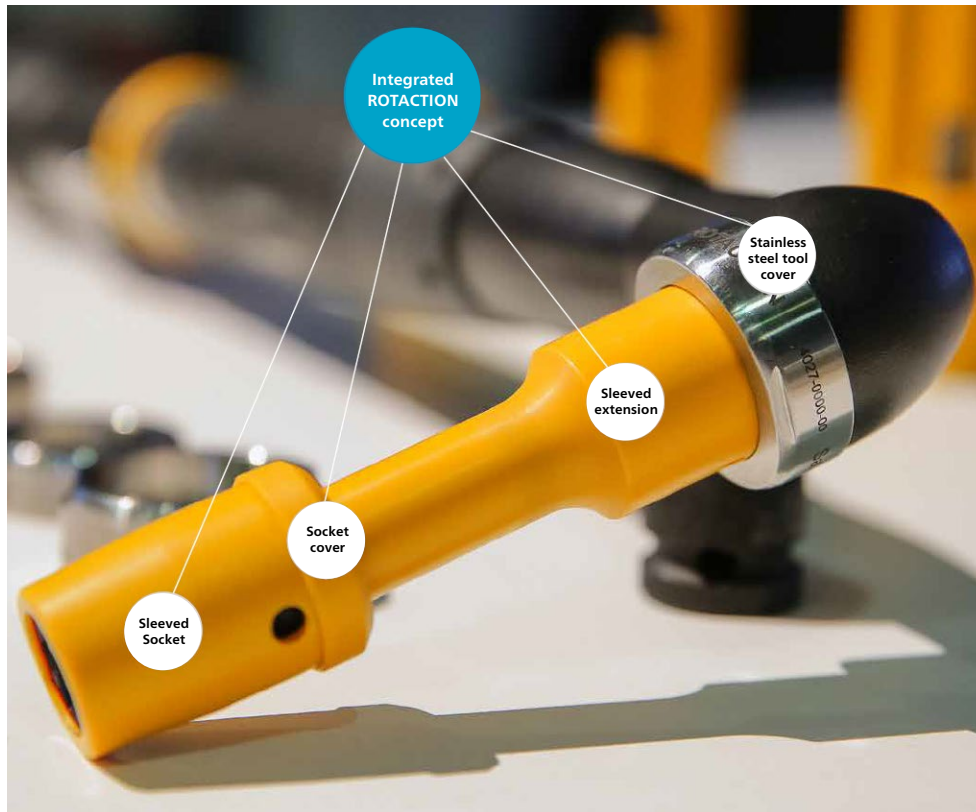

Tool covers for tools with Hex drive

Saltus has a wide range of tool covers for Atlas Copco tools with Hex drive, both pistol grip and straight models. Below is an example of this:

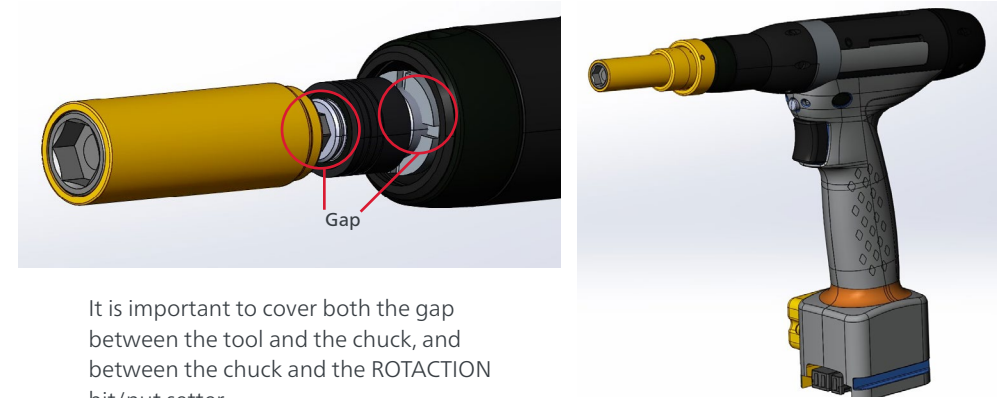

It is important to cover both the gap between the tool and the chuck, and between the chuck and the ROTACTION bit/nut setter.

Above example illustrates tool ETP ST32-10-I06 with tool cover

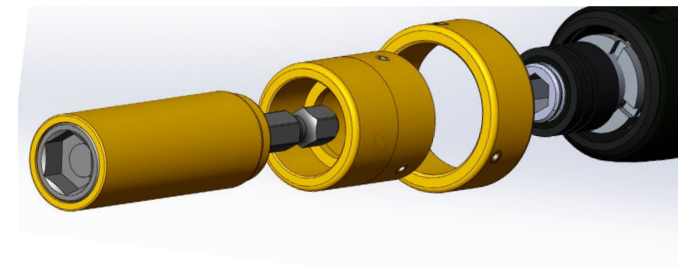

For some tools we have a two-piece tool cover solution to cover the gap. This two-piece solution offers the possibility of using the tool covers for different chuck lengths, to adjust and mount the tool cover as close as possible to the tool, to minimize the gap.



4.1.2 ROTACTION: added value

In addition to improving operational efficiency, ROTACTION products offer these advantages:

- Small outer dimension for better joint accessibility
- Minimized risk of scratches and marks on painted objects and surfaces
- High resistance to abrasion
- Low friction, allowing for high accuracy of power tools
- Reduced user influence on tightening
- Improved perceptibility under low light conditions



4.2 Ergonomic tightening

We know that good ergonomics can have a significant impact on productivity, quality and the work environment. We began our ergonomic program as early as the 1950s. All our products must pass a solid ergonomic review before they make it to the market. The same standards apply to our sockets.

4.2.1 Guided ROTACTION sockets

Increased operator safety + improved torque transmission to the joint

Our ROTACTION concept answers the increasing demand for operator safety. The combination of freely rotating sleeves, "tool-to-socket" tool covers and "extension-to-socket" socket covers, significantly improves operational efficiency. This also reduces operator influence on tightening.

Thanks to extra stability from the elongated sleeve, the socket delivers improved torque transmission to the joint.

Paired together we call it "Guided ROTACTION". It protects operators and maintains tightening accuracy.



What makes the ROTACTION socket outstanding

- A** The ROTACTION sleeve protects the user while the socket rotates on the inside. This provides a safer operation and reduces user influence on tightening.
- B** The socket itself has a circular collar that extends past the square drive to give extra stability. As a result, wobbling is eliminated and the socket is held stable. This maintains force and improves operator comfort.
- C** The tool cover closes the gap between the tool and socket.
- D** A magnet secures the nut inside the socket.

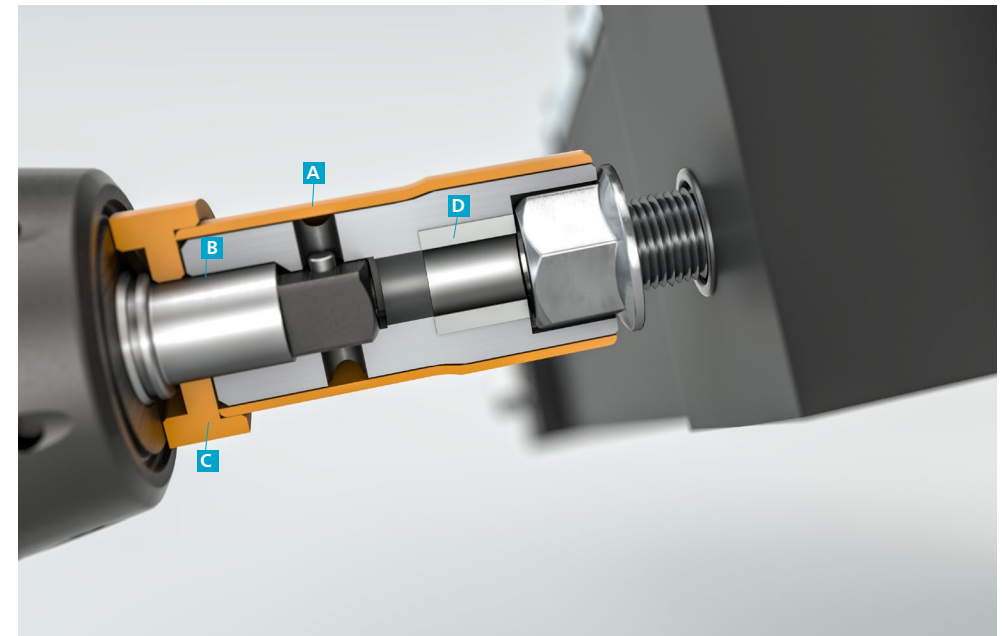

4.2.2 Guided ROTACTION extensions

Also guided function in the output drive

The same features you find in our Guided ROTACTION sockets are also found in our Guided ROTACTION extensions. For example, the input of the extension has a circular collar that extends past the square drive, and provides extra stability.

The Guided ROTACTION extensions have one extra feature: a circular part before the square output drive similar to the output drive of a pulse tool. This feature ensures that the guided ROTACTION socket is held stable in the connection between socket and extension which improves torque transmission to the joint.

Guided ROTACTION sockets and extensions

- Reduce vibrations; ergonomic
- Minimize risk of injury
- Reduce user influence on tightening
- Give extra stability
- Improve torque transmission to the joint
- Less wear on tools and sockets

Guided ROTACTION extensions have the guided functionality in both their input and output drive, which is unique to Saltus.

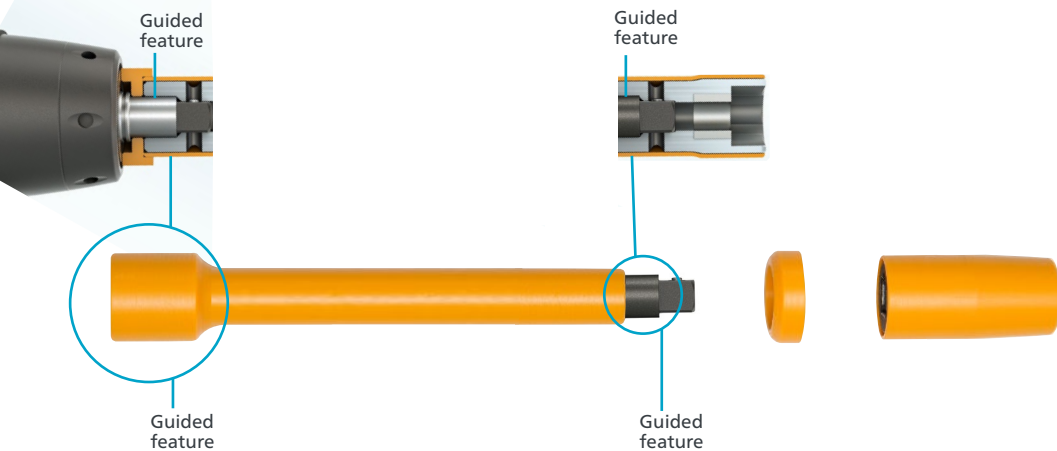

Extension with guided feature

See [Section 11.1, Solution 3](#), for an example of the utility of a guided socket and extension in a work setting.

05

Tightening on live EV batteries

In recent times there has been a big push towards e-mobility. Bloomberg estimates that by 2025, 10 million EV cars will have been sold worldwide. An average EV vehicle has battery packs with voltage levels between 500 V and 1000 V, which are often tightened on live terminals. For people working on electric vehicle batteries, this means that special procedures and safety precautions need to be observed. For example, there is the danger of short circuits in live components which could result in an electric shock. Safety should **be the top priority!**

5.1 Isolated and insulated solutions

In view of the risks posed by the assembly of live components, Saltus has developed **isolated sockets, Quick Change Adapters (QCAs), and insulated tool covers** for Atlas Copco power tools. These solutions prevent direct contact with live components, short circuits (high electrical currents, electric arcs, exploding batteries), and short circuiting of battery modules with grounded tools. This protects assembly personnel.



How it works



Thanks to a specially processed composite core, Atlas Copco's isolated sockets and QCAs provide **isolation in the axial direction** which completely cuts off electrical conductivity between the bolt and the tool.



Furthermore with freely rotating sleeves, the isolated sockets and QCAs are **insulated in the radial direction**.

Screw side

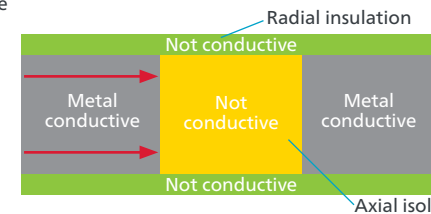

Tool side



The graphic shows a cross-section of an isolated socket.

In the coming sections we will use the term "isolation" when referring to isolation in the axial direction and the term "insulation" when referring to insulation in the radial direction.

5.2 Product range: isolated socket solutions

Below is an overview of the existing standard product range for Saltus isolated solutions. It includes isolated sockets, QCAs and extensions for power tools. We also offer customized isolated solutions, for example extra-long or thin sockets for better accessibility (see [Section 6](#)).

Our standard range of isolated sockets, QCAs and extensions are developed to be used with direct driven tools. Maximum tightening torque is 30 Nm and a two-step tightening strategy is recommended. Our standard range of isolated sockets, QCAs and extensions, cannot be used with pulse tools.

Isolated sockets

Isolated sockets are isolated in the axial direction and insulated in the radial direction.

- Input: 3/8"
- Output: surface drive 8 mm, 10 mm, 12 mm, 13 mm, 15 mm and 16 mm
- Feature: with ring magnet



Isolated Quick Change Adapters and extensions

Like isolated sockets, isolated QCAs are isolated in the axial direction and insulated in the radial direction. Observe that when you use isolated QCAs or extensions, these must be used in combination with adequate insulated socket covers, Saltus ROTACTION sockets, bit sockets, extensions, or bits without ROTACTION. This will be explained in detail in "A modular system" on [page 28](#).

For tools with square drive

- Isolated QCA: input female 3/8" -> Output 3/8" Sq Dr
- Isolated QCA: input female 1/2" -> Output 3/8" Sq Dr
- Isolated QCA: input female 3/8" -> Output 1/4" Hex drive style E
- Isolated QCA: input female 1/4" -> Output 1/4" Hex drive style E



DID YOU KNOW?

While most screws used in the assembly of EV batteries require 5-20 Nm to be fastened, our isolated sockets can withstand up to 30 Nm, provided there is no misalignment between the socket and the screw.

Isolated extension: input female 3/8" -> Output 3/8" Sq Dr
The isolated extensions can be delivered with different options to connect the socket to the square output:

- Ball retainer
- Pin retainer
- Magnet



For tools with female Hex drive

- Isolated QCA: input male Hex 1/4" -> Output 1/4" Hex drive style E
- Isolated QCA: input male Hex 1/4" -> Output 3/8" Sq Dr



Guided isolated sockets, QCAs and extensions

Our isolated sockets, QCAs and extensions can also be supplied with a guided function on special request, both for angle head power tools and robotic applications. The guided function finds demand wherever vision systems are used.



Example of isolated QCAs in a robotic application

A modular system

The isolated QCAs* have been developed as a modular system, to be used in combination with our standard ROTACTION sockets, bits and extensions, with sleeves or standard bits style E available from stock. Compatibility with the existing ROTACTION program gives flexibility with several hundred different socket combinations and the convenience of not needing to order special isolated sockets.

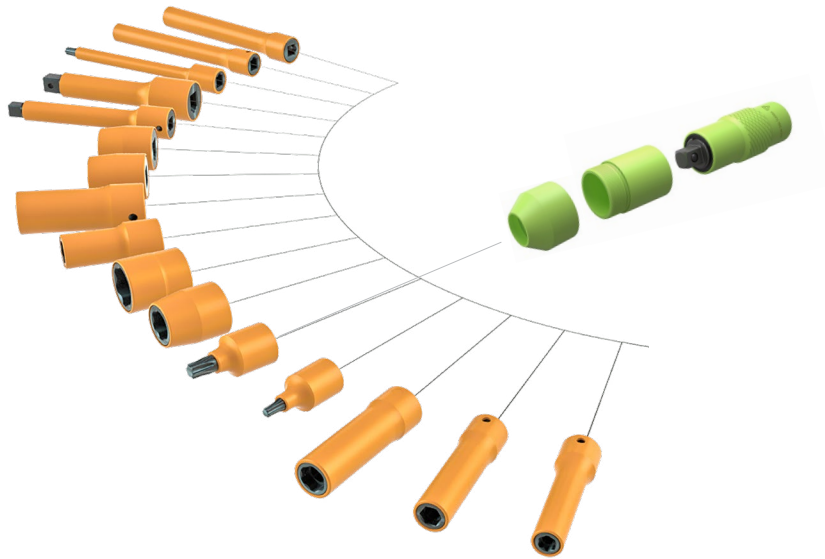

Insulated socket covers

When isolated QCAs are used in combination with Saltus ROTACTION sockets, bit sockets, extensions and bits, insulated socket covers must be used to close the gap between the isolated QCAs and the different ROTACTION articles/parts, to ensure complete radial insulation and to fulfill applicable parts of the IEC 60900 standard. Saltus has a range of insulated socket covers for different combinations and it is important that the correct insulated socket cover is used for the chosen combination.

Below are the basic versions of insulated socket covers: A, B, C and D

- A** Socket cover base
- B** Socket cover base nose
- C** Socket cover base nut (only needed when using extension)
- D** Socket cover nose (only needed when using extension)

* An isolated extension can be used in the place of an isolated QCA.

Insulated socket covers for QCAs with output 1/4" Hex drive style E

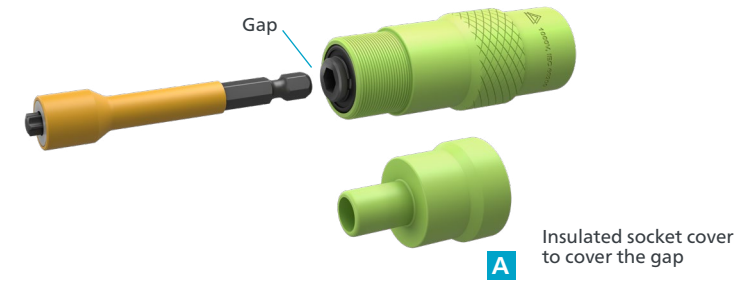

Insulated socket covers for QCAs with output 3/8" Sq Dr

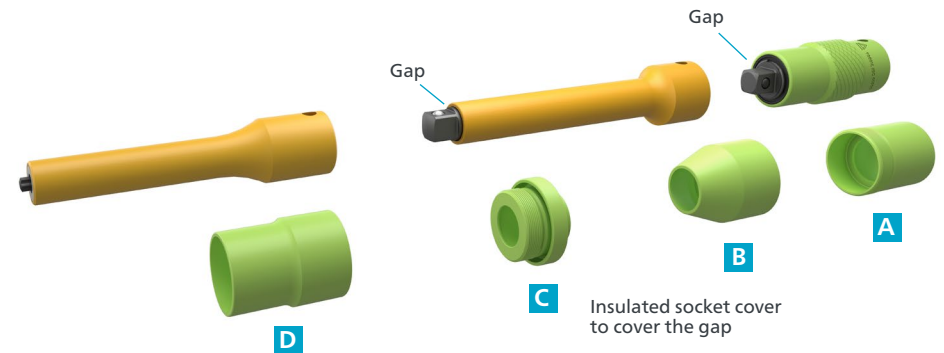

The basic concept is that the different insulated socket covers are fastened with left-handed threads*. For more detailed information on how to assemble the insulated socket covers refer to the installation manual for isolated QCAs. Next we have three use cases that explain how to use insulated socket covers.

Important instructions

- Always use the isolated QCA with adequate insulated socket covers and Saltus ROTACTION sockets, bit sockets, extensions and bits or bits without ROTACTION.
- Do not use sockets from other brands in combination with the isolated QCA.
- Do not use the isolated QCA if it is damaged in any way or if it is not correctly installed.

*For outputs >15 mm, there is just one insulated socket cover without threads and the insulated socket cover is also not connected to the ROTACTION socket or bit socket.

How to use insulated socket covers: three main use cases

Below we show the three most common use cases showing how insulated socket covers are used when combining our isolated QCAs* with Saltus ROTACTION sockets, bit sockets, extensions and bits.

Use case 1

Insulated socket cover for isolated QCA with output female 1/4" Hex style E drive in combination with ROTACTION bits, nut setters or standard bits style E.

When you use isolated QCA with female 1/4" Hex drive output you only need one insulated socket cover to cover the gap between the QCA and the ROTACTION bit/nut setter or bit. Both the QCA and the insulated socket covers have left-handed threads that are used to fasten the socket cover to the QCA.

Unassembled parts

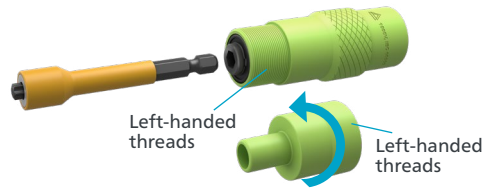

Assembled solution



Use case 2

Insulated socket covers for isolated QCA* with Sq Dr 3/8" output in combination with ROTACTION socket or bit socket.

When you use isolated QCA with output male 3/8" Sq Dr in combination with a ROTACTION socket or bit socket you need two** insulated socket covers to cover the gap between the QCA and the ROTACTION socket or bit socket. Both insulated socket covers have threads that are used to fasten the insulated socket covers to the ROTACTION socket or bit socket.

Unassembled parts

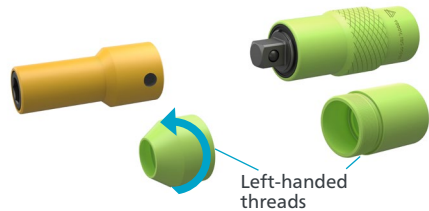

Assembled solution



* An isolated extension can be used in the place of an isolated QCA.
 **For outputs >15 mm there is normally just one insulated socket cover without threads and the insulated socket cover is also not connected to the ROTACTION socket or bit socket.

Use case 3

Isolated QCA for 3/8" Sq Dr – output male 3/8" Sq Dr in combination with a ROTACTION extension and ROTACTION socket or bit socket.

Unassembled parts

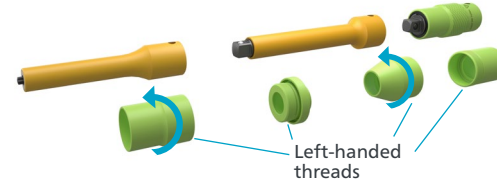

Assembled solution



When you use an isolated QCA with output male 3/8" Sq Dr in combination with a ROTACTION extension and a socket or bit socket, you need four insulated socket covers to cover the gaps between the QCA and the ROTACTION extension, socket or bit socket. All four insulated socket covers have threads that are used to fasten the insulated socket covers to the ROTACTION socket or bit socket.

Signal green

We've used green to indicate that the article is isolated and insulated and safe to use for EV battery assembly.

SIGNAL COLOR GREEN

Color coding for clear and quick identification of **isolated products**

New isolated sockets and Quick Change Adapters

Isolation in axial and insulation in radial direction

Color coding for **ROTACTION range**

ROTACTION sockets and bits available as a modular add-on system

SIGNAL COLOR YELLOW

All green items are IEC 60900 compliant including:

- Isolated QCAs
- Insulated socket covers

ROTACTION and isolation when working on live components

The freely rotating sleeves concept ROTACTION is integrated into our isolated solutions.

All our isolated sockets, QCAs and extensions are insulated in the radial direction by freely rotating sleeves. Our ROTACTION concept with freely rotating sleeves is integrated into the same functionality, to reduce the risk of entanglement.

When we use our isolated QCAs in combination with our ROTACTION range and insulated socket covers, the whole solution from input to output has freely rotating sleeves. The isolated sockets prevent direct contact with live components and reduce the risk of entanglement.

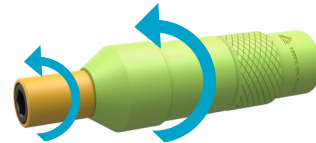

Freely rotating sleeves for insulation and reduced risk of entanglement

Advantages of our isolated sockets and QCAs

- Live working; for use up to 1000 V AC and 1500 V DC
- Isolation in axial and insulation in radial direction
- Modular system: isolated QCAs can be combined with several hundred different ROTACTION sockets
- Easy-to-assemble insulated socket covers
- ROTACTION function is integrated in the isolated sockets and QCAs
- Green color coding for clear and quick identification of isolated products
- Compact design; similar to current standard ROTACTION sockets
- Very good durability*
- Very good resistance against indentation
- Passed test at VDE Testing Institute, according to applicable standards (standard IEC 60900)
- Marked according to the standard IEC 60900 with double triangle, IEC 60900 and 1000 V
- Most of the articles are available from stock
- Manages torque up to 30 Nm
- All isolated sockets and QCAs are 100% tested for electric isolation before delivery



5.3 Tested

Even though a single applicable standard for isolated sockets used with power tools is not yet available, the applicable sections of DIN EN IEC 60900:2018 were investigated and various tests identified to ensure the mechanical strength and isolating properties of the sockets. For example, the dielectric test was carried out and confirmed by both VDE (Verband der Elektrotechnik Elektronik Informationstechnik e.V.) and the Intertek laboratory.

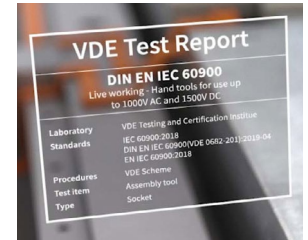

The successful completion of the VDE tests entitles us to display the double triangle symbol on our isolated tools, in accordance with DIN EN IEC 60900:2018. Intensive testing was also carried out internally. These tests included endurance tests and indentation tests, as well as tests to investigate the flammability of the composite used.

The VDE test result is applicable for assemblies of QCA and ROTACTION sockets / bits / extensions, to test that these are combined according to certain rules. As each single ROTACTION product must be combined with suitable insulated socket covers, the single (ROTACTION) product is not marked. The insulated socket covers are also marked with 1000 V, double triangle and IEC 60900.



Our isolated sockets and insulated socket covers are marked with:

- Double triangle
- IEC 60900
- 1000 V



The double triangle test symbol (in accordance with DIN EN IEC 60900:2018) indicates that users can work with these tools at voltages of up to 1000 V.

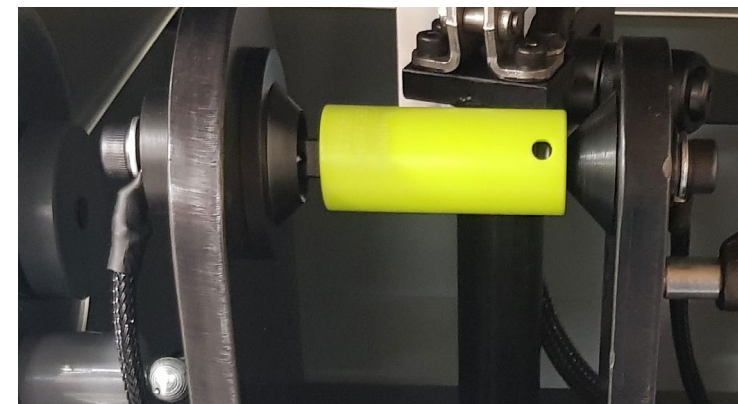

The picture shows an isolation test in progress

* Provided there are no side forces on the socket or misalignments of the socket and the bolt axis.

5.4 Insulated tool covers

Always use insulated tool covers when you use isolated sockets, extensions or QCAs in combination with handheld tools. The well-thought-out design of the insulating covers consists of non-conductive plastic and a two-part shell structure that can be simply clipped to the electric tool. With an additional rubber ring and a front cover nut, tools used in the assembly process are effectively insulated and protected. This avoids short circuits caused by accidental contact between the metal angle head and live components. There are also insulated tool covers for certain pistol tools.

Advantages of our insulating covers for EC power tools

- Smart, engineered design for tight space installation
- "Accuracy of fit and installation safety": very precise overlapping of plastic cover, reduces the chances of entanglement
- Quick and easy installation
- Ergonomic and lightweight design
- Green color coding for clear and quick identification of insulated tool cover
- **Ready to be used with Atlas Copco tool holders**



Assembly instructions:

1. Remove rubber ring and cover nut.
2. Unclasp and separate top and bottom.
3. Attach top and bottom around tool, make sure there is a click from the clasps.
4. Pull rubber ring over cover and back into designated slot. Tighten the cover nut.

The Atlas Copco Tool Cover is a solution to insulate conductive parts of an Atlas Copco handheld electrical power tool that are in close proximity to the high voltage area during work on or around EV batteries. It is to be used with the Atlas Copco / Saltus isolated sockets, providing electrical isolation and insulation axially and radially.

Insulated tool cover solution for pistol tools



Insulated tool cover solution for battery tool with battery foot cover



EV battery assembly:

1 integrated fix for 3 common risks

Below are three possible risk areas and accident scenarios connected with the pre-assembly of electric vehicle batteries. They make one thing clear: work on live battery connections calls for special, intensive training of operators, adapted assembly processes and particularly, the use of special tools to minimize the risk of injury.

SCENARIO 1: RISK

Direct contact with live components



The operator makes direct contact with live components. If properly insulated tools and equipment are not used, voltages upwards of 120 V DC could result in severe injuries and possibly death.

Isolated contact with live components



Using isolated sockets or QCAs (with their axial isolation and radial insulation) cuts off electrical conductivity between the bolt and tool isolating up to 1000 V. Isolated QCAs must be used in combination with ROTACTION sockets and insulated socket covers.

SCENARIO 1: SOLUTION

SCENARIO 2: RISK

Short-circuiting of battery modules with grounded tools

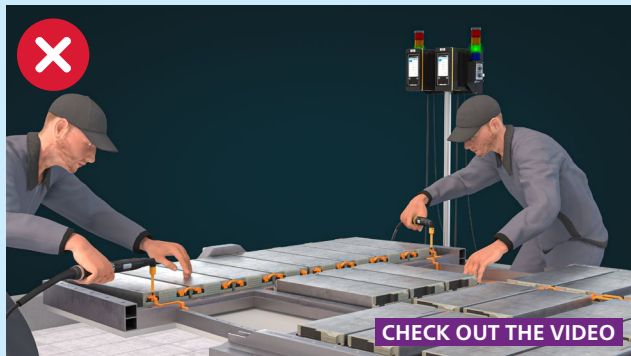

A second risk is the short-circuiting of live components with grounded tools. If at least two grounded tools with common ground are used at the same time, contact with two battery poles may lead to short-circuiting. This poses a risk to the operator as well as the materials and equipment.

Protection of grounded equipment with isolated sockets/QCAs and insulated tool covers



The solution for risk Scenario 2 is basically the same as Solution 1. It is just that you need to have both tools equipped with isolated sockets or QCAs (with their axial isolation and radial insulation) that cut off electrical conductivity between the bolt and the tool isolating up to 1000 V. Isolated QCAs must be used in combination with ROTACTION sockets and insulated socket covers which reduce the risk of severe injury or fatality during the tightening process.

SCENARIO 2: SOLUTION

Short-circuit of live components with non-insulated tools and equipment



A third risk is posed by direct shorting of the battery cells. That occurs when contact is established between live components via non-insulated tools. Such short circuits may result in arcing, gassing, fire, or explosion. This poses a risk to the operator as well as the materials and equipment.

No contact between live components with insulated tools



Insulated tool covers consisting of non-conductive composite material used on the tool reduce the chances of short circuits caused by accidental contact between the metal angle head and live components.

The integrated isolated system

- First of all you should use isolated sockets or QCAs that cut off electrical conductivity between the bolt and the tool.
- QCAs must be used in combination with ROTACTION sockets, bits or extensions.
- Insulated socket covers must be used to cover the gap between the QCA and the socket, bit or extension to prevent direct contact with live components.
- Insulated tool covers must be used on the tool to avoid short circuits caused by accidental contact between the metal angle head and live components.

SCENARIO 1 + 2 + 3

Any or all of these three scenarios described here are likely to happen at any time. For total protection, consider the integrated isolation system.



06

Customized sockets and bits

When you cannot find a standard socket or bit to fit your needs, the clear next step is to request a new, custom item. At the Saltus Competence Center, a dedicated sockets and bits team handles custom requests, product design, and production control. If you do not find solutions to your assembly challenges among our standard socket products, our Sockets and Bits Team will work closely with you to develop an optimal solution customized to fit your application needs.

With our proven experience developing custom products for difficult or unusual assembly applications, our Socket Specialists can design a custom solution that not only satisfies your application requirements but also helps to optimize your production processes and to add value to your business.

6.1 Customizable factors

Below are a few examples of customizations that can we provide.

Spring loaded finder sleeve
Open Socket
Flush
Long-life
Protective and ROTATION sleeves
Spring-mounted length compensation
Outer diameter
Splines
Universal Sockets
Length
Socket with quick-change coupling on drive
Magnets
Input Cross Hole
Spring mounted ejector
Combination sockets

Isolated
Guided
Socket with clamp
Socket with clamp

special

6.1.1 Length

We can provide sockets or extensions up to 1600 mm.



6.1.2 Outer diameter

We can provide sockets with an outer diameter of up to 315 mm.



6.1.3 Wall thickness

Sockets with smaller outer diameters can be provided. These are often critical for accessibility. Surface drive output profiles are ideal for thinner sockets, as opposed to Hex, due to the force that is transferred via the flats, not the corners. This minimizes the risk of socket breakage.



6.1.4 Protective sleeves

Socket with rotating protective sleeve

Sockets with rotating protective sleeves prevent damage to the assembly parts and the surrounding screw. Sockets with protective sleeves are especially effective in protecting painted or coated surfaces. The rotating function of the sleeve makes it possible to use the socket wrench to guide bolts manually. An optional integrated magnet is available (ring or spring-mounted) in order to hold the screw and facilitate the tightening process.

Sockets with fixed protective sleeve

Thanks to the fixed protective sleeves at the drive of the socket and at the surface of the socket head, sensitive components including aluminum rims or painted surfaces are protected. Protective sleeves minimize the risk of scratches and damage to painted surfaces and the surrounding area.



6.1.5 ROTACTION sockets and bits

ROTACTION sockets and bits can be customized with special lengths, wall thicknesses, and many other configuration options. Operator safety can be significantly improved using our freely rotating sleeves, along with covers for 'tool-to-socket' and 'extension-to-socket' connections.



6.1.6 Magnets

Sockets, bits, or nut setters can come equipped with custom magnets.

Ring-magnet for holding a nut

When screwing the nut, the stud goes through the hole.

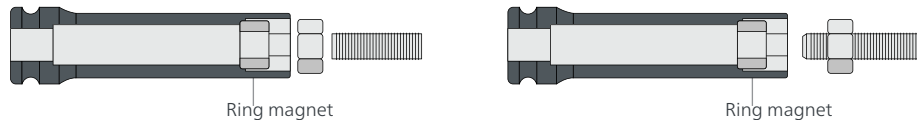

Magnet integrated in the front of a nut setter

A magnet can be integrated onto the front of the screw to effectively hold the screw/nut in place when tightening.



Magnet integrated in the tip of bit

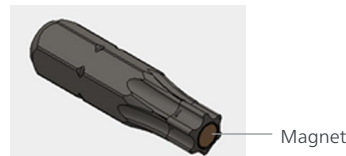

6.1.7 Guided sockets

Guided sockets are used on applications which requires very little play between the output shaft of the tool and the socket. This is highly preferred on pulse tools or low reaction tools. Guided sockets work to reduce wobbling in order to deliver the correct torque to the joint. There are also other applications where guided sockets are needed, for example robot applications or horizontal mounted fixtured tools.



An example of an application that is often mounted with the tool in a horizontal position is assembly of the flywheel on the clutch where exact alignment is required. We have a standard range of guided sockets, extensions, bit sockets, bit holders, and QCAs. These standard options can be customized by request (See [Section 4.1.2](#) for more information on custom guided ROTACTION sockets).

What makes our guided ROTACTION sockets outstanding:

- A** The ROTACTION sleeve protects the user while the socket rotates on the inside. This makes the operation safer and reduces operator influence during tightening.
- B** The socket itself has a circular collar that extends past the square drive to give extra stability. The socket is held stable and eliminates wobbling, thus maintaining force and improving operator comfort.
- C** The tool cover closes the gap between the tool and the socket, protecting the operator from the risk of entanglement.
- D** A magnet secures the nut inside the socket.

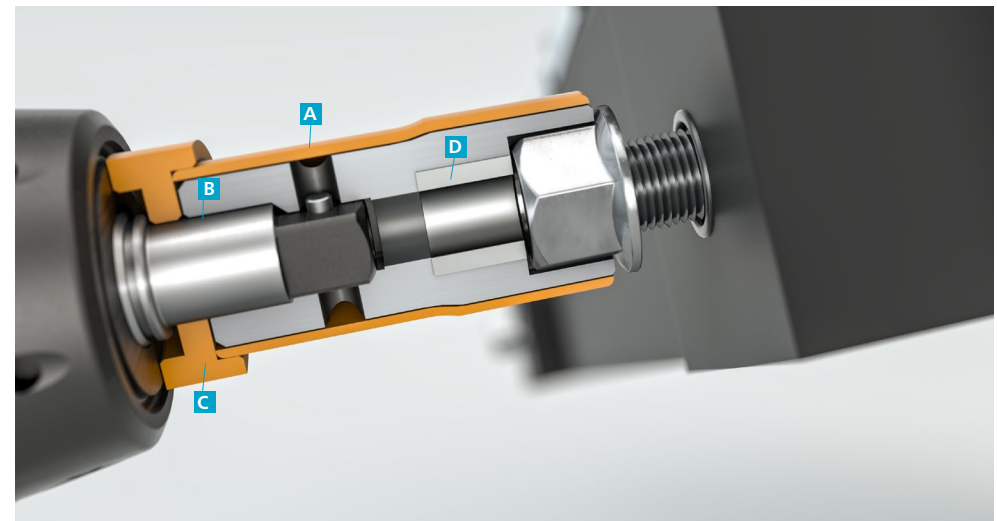

6.1.8 Long-life sockets

Developed for powered tightening systems, long-life sockets from Saltus have an impressive service life and are wear-resistant.

Long-life sockets are made from a new material with a high-level of wear-resistance and long-term elasticity. Depending on use, long-life sockets can last three to ten times longer than conventional sockets.

Long-life sockets are characterized by their gold surface coating. This ensures that they easily stand out from other socket types and won't be confused or misused.



6.1.9 Input cross holes

Input cross holes are used with QCAs with male squares. Visual inspections are not necessary.

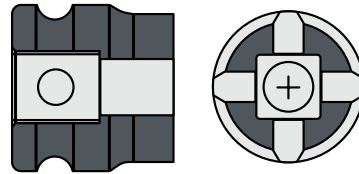

6.1.10 Open socket

Open sockets that feature a large cutout on the shaft of the socket are ideal for tightening with cables, hoses, etc. Used in conjunction with a torque wrench, open sockets allow for access to tightening spots that are difficult to reach.



6.1.11 Universal sockets

Universal sockets with locking spring

The locking spring makes it possible to fix the joint at an angle of up to 30 degrees in any position. Universal sockets with a locking spring are ideal for difficult-to-reach assembly parts.



Universal sockets with an alignment spring

Universal sockets that feature an alignment spring are able to fix the joint at an angle of up to 30 degrees. Ideal for bolts with axes that do not align or are hard to access, the alignment spring returns the joint to the original position. The integrated magnet holds the screws and simplifies the tightening process.



6.1.12 Spring-mounted length compensation

Sockets with the spring-mounted length compensation feature ensure length compensation during the tightening process.



6.1.13 Spring-loaded ejector

Sockets with a spring-loaded ejector prevent screws from getting stuck in the socket after being loosened.



6.1.14 Spring-loaded finder sleeve

Sockets that have a spring-loaded finder sleeve fix the screw head in place to prevent slippage. The spring-loaded finder spring prevents the drive from engaging the screw head until it is fixed. This feature is especially suited for inner-profile screws that often require insertion via a little bit.



6.1.15 Combination sockets

Combination sockets are ideal for lowering equipment costs if different screw connections at the same station must be alternated. The smaller drive is spring-mounted inside the larger drive.



6.1.16 Sockets with clamp

When you need to hold non-magnetized screws or nuts with the socket, you can consider using a socket with a ball-bearing in the output to hold the screw or nut in place for reliable tightening.



6.1.17 Sockets with quick change coupling on drive

Customized sockets with a quick change function at the drive, make it possible to exchange sockets quickly. Usually used for sockets when either a QCA is either not available or not to be used. It's an ideal option when different tightening technologies must be alternated.

We have solutions for power tools with male square drives with a spring-mounted pin retainer (1) and for square drives with a through hole (2).

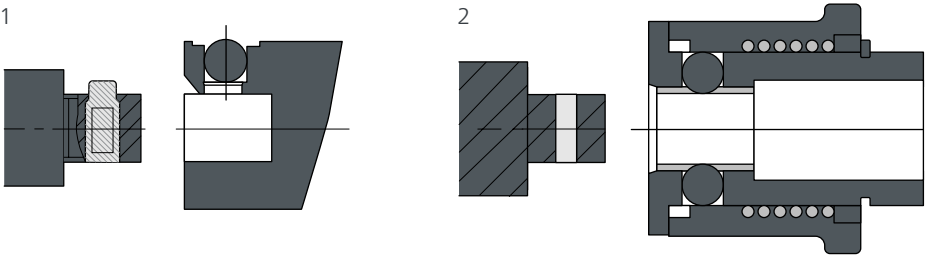

6.1.18 Splines

Sockets with special drive profiles

Sockets with splines are ideal for tightening stations with special drive profiles.

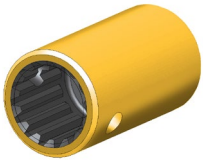

View of the socket from the input side



View of the socket from the output side

6.1.19 Flush sockets

Flush sockets can be customized on request. Please note that special power tools must be used for flush sockets.

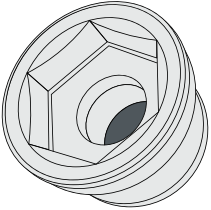

Hexagon socket "HEX" type

We can also customize flush sockets for flush socket tools.

6.1.20 Customized isolated sockets

For complex tightening applications, such as those for EV battery assembly, custom isolated sockets can be ordered.

Below are two examples of customized sockets. The first picture shows a custom guided isolated bit holder being used with a nut setter on an angle head tool. The second picture features a custom isolated flush socket.

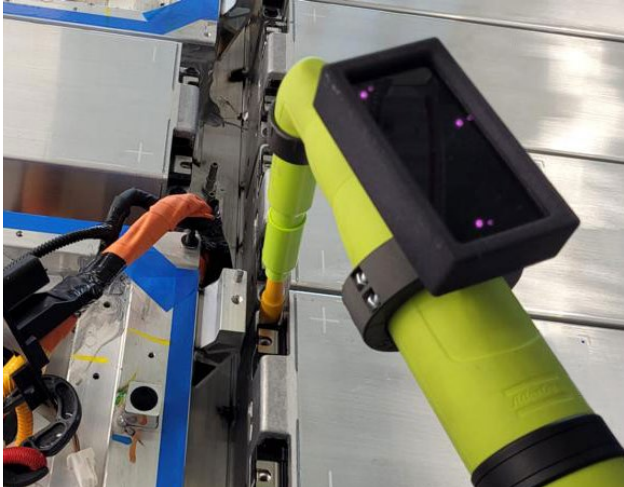

Guided isolated bit holder for angle head tool



Isolated flush socket for better accessibility

07

Sockets and bits: standard Saltus portfolio

There is a wide choice of sockets and bits to choose from, in the market. Whether you're looking for a small, 4 mm halfmoon bit for the assembly of state-of-the-art smartphones, or a 2 1/2" Hex socket for the manufacture of windmills, we have it all. For any tightening application, our comprehensive range of Saltus sockets and bits can support your production. Our sockets and bits are ideal for power tools, fixtured stations, and robotic systems.

Saltus supports you with the right sockets and bits for any tightening application. Saltus sockets are ideally suited for power tools, fixture stations, and robotic systems.

Highlights

- Standard portfolio with 2600 sockets and bits.
- For a large part of our standard sockets and bits range, we offer our ROTACTION concept with freely rotating sleeves.
- Comprehensive range of isolated sockets and QCAs for work on live systems (e.g., EV batteries). See [Section 5](#).
- Products with excellent performance available from stock..





Standard socket and socket products offered:

Sockets	Bit Sockets	Nut Setters	Stud Setters
			
Extensions	Adapters	Bits	Bit Holders
			

Sockets

Sockets are characterized by a female square drive at the input end, and are available from 1/4" up to 2 1/2". Our sockets are available in standard (SAE) and metric sizes.

Output drives

-  Hex
-  Surface drive
-  Double Hex
-  For Torx® screws
-  For Torx Plus® screws

Optional features

- Different magnet types
- Thin walled
- ROTACTION
- Guided
- Lead-in chamfer
- Different lengths for accessibility



7.1 Sockets: output drives

Below we describe in more detail the different output drives for sockets:

7.1.1 Traditional Hex drive

A traditional Hex drive is designed with flat walls to guarantee flat surface contact between the socket and the bolt/nut.



7.1.2 Saltus Hex drive

The Saltus Hex drive is an optimized (traditional) Hex drive with slightly curved walls that ensure better contact between the surfaces of the socket and the fastener. This allows for torque to be transmitted more efficiently and it also reduces wear.



7.1.3 Surface drive

A surface drive is designed with curved walls for closer contact with the center of the flat of the fastener, for off-corner loading to reduce wear in the corners of the fastener and for improved transmission of torque. This minimizes the risk of damage to the fastener and is therefore useful for chrome/painted fasteners or fasteners made from soft materials. The surface drive also makes it easier to match the screw head which makes work more efficient.



7.1.4 Double Hex

The double Hex is able to fit over a hexagonal bolt head in twice as many positions as the regular Hex socket, and is therefore a good choice if you are working in a tight space.

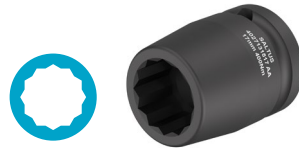

7.1.5 Torx®

Specially designed for Torx® fasteners, Torx® sockets have a six-point star profile. This helps to maintain the correct degree of torque while reducing the chance of slippage and damage to surrounding surfaces during tightening.

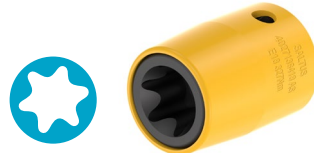

7.1.6 Torx Plus®

Designed for Torx Plus® fasteners, Torx Plus® sockets are designed for even higher transmissions with next to no chance of slippage. This extends tool life and reduces socket wear.

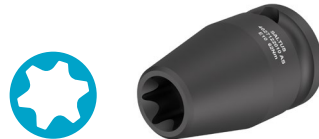

NOTE: Torx®, Torx Plus® are registered trademarks of Acument Intellectual Properties, LLC.

7.2 Sockets: optional features

Below we describe more in detail the different optional features for sockets:

7.2.1 Thin-walled sockets

Thin-walled sockets are made with reduced outer diameter to improve accessibility. Thin-walled sockets should not be used for high torque applications.



7.2.2 Sockets with magnets

Fixed magnets

A fixed magnet helps in picking the fastener for more efficient handling.



Socket with spring-mounted magnet

The spring-mounted magnet makes it possible to tighten nuts on stud bolts easily and securely. The magnet holds the nut in the socket and moves with the tightening of the nut on the stud. A ring-magnet is an alternative solution (See [Section 6.1.6](#)).

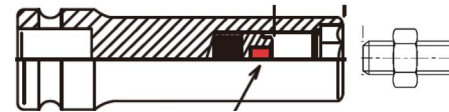

7.2.3 Socket with lead-in chamfers

The lead-in support at the output drive makes it easier to match the screw head while the screwdriver is running.



NOTE: Torx®, Torx Plus® are registered trademarks of Acument Intellectual Properties, LLC.

7.2.4 Sockets for self-tapping screws

Sockets for self-tapping screws have a higher hardness and normally fitted with magnets.



7.2.5 Universal sockets

Using a universal socket, it is possible to tighten the joint at an angle of up to 30° in any position.

Due to the torque limitations of universal sockets, we recommend using a wobble adapter (See [Section 7.7](#)) with a standard socket instead.



7.2.6 Sockets for wheel nut runners





Thanks to the fixed plastic protective sleeve at the drive end and before the head at the surface, sensitive components such as aluminum rims or painted parts are protected, in addition to the surrounding area.



7.3 Bit sockets

When a socket is combined with a bit, it is known as a bit socket. Bit sockets are characterized by a square drive at the input end. They are available in the range of 3/8" to 1". It is important to match the right bit socket with the right fastener in order to prevent damage to both the fastener and the bit socket.

Output drives

-  Hex
-  XZN
-  For Torx® screws
-  For Torx Plus® screws



Optional features

- Magnet
- Guided
- ROTACTION
- Different lengths for accessibility

Tired of losing bits during assembly?

Bit sockets are for you. Now you can tighten and loosen all kinds of fasteners (flathead, Phillips, Hex or star-head) without worrying about bits falling out.

7.4 Nut setters

Characterized by a 1/4" male Hex drive style E at the input end, nut setters are used in the tightening or loosening of any fastener. Nut setters are also available with 7/16" male Hex drive style E input and Halfmoon 04 mm drive input. The nut setter's output fits around the fastener while the input fits into the power tool. Nut setters grip the head of the fastener while driving down the nut. Magnetic nut setters are useful when working in areas that are hard to reach which is also helped by their smaller outer diameter compared to sockets, however this implies that they handle lower torques compared to sockets.



Output drives

-  Hex
-  For Torx® screws

Optional features

- Magnet
- ROTACTION
- Universal nut setter (available for 7/16" male Hex drive style E)

7.5 Stud setters

Stud setters are meant for mounting stud bolts with a security sleeve to reduce rework costs by protecting the tightened components. Though not suitable for use with impact screwdrivers, they are suitable for heavy loads. Stud setters are available in a wide variety of choices and are particularly suitable for tightening in cramped spaces.



NOTE: Torx®, Torx Plus® are registered trademarks of Acument Intellectual Properties, LLC.

NOTE: Torx®, Torx Plus® are registered trademarks of Acument Intellectual Properties, LLC.

7.6 Extensions

Socket extensions are ideal for all types of power tools. Fitted between the tool drive and the socket, extensions enlarge the operational area of sockets for the purpose of loosening or tightening fasteners. Extensions are characterized by a female square drive at the input end and a male square drive at the output. They are available in the range of 1/4" to 1 1/2".

Output drives with different fixture systems

There are **three common ways** to connect a socket to the output drive of an extension:

- **Pin retainer**

To disassemble the socket, the pin must be pushed down.

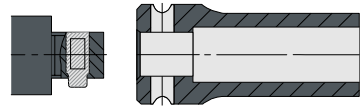

- **Through hole (use Pin & O-ring)**

- **Ball retainer**

Ball retainers make it easy to disassemble the socket. However it should be noted that such a connection is not 100% secure.

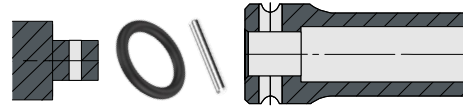

It should only be used for square drives up to 1/2" and the maximum weight that can be attached to the square drive must not exceed 0.5 kg.

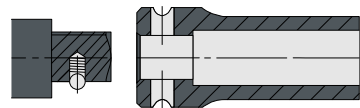

NOTE

- Ball retainers make it easy to disassemble the socket. However such a connection is not 100% secure.
- The maximum weight which can be attached to a 3/8" square drive with ball retainer must not exceed 0.5 kg.
- The maximum weight which can be attached to a 1/2" square drive with ball retainer must not exceed 1 kg.

Optional features

- Guided
- ROTACTION
- Different lengths for accessibility



NOTE: Torx®, Torx Plus® are registered trademarks of Acument Intellectual Properties. LLC.

7.7 Adapters and QCAs

Adapters fit between the tool and the socket to allow the socket to adapt to the tool drive that is of a different size or shape than the socket. QCAs allow you to change sockets without requiring the use of Pin and O-ring combinations. This means that you can have a QCA mounted on a tool and then easily change several socket types.

Different types

- Input female square to output male square adapters in multiple versions and sizes: e.g., 3/8" -> 1/4", 1/2" -> 3/4" etc.
- Adapters for male Hex to male square in different combinations and lengths, for example, 1/4" or 7/16" -> 3/8" in lengths 50 – 200 mm
- Quick Change Adapters for square drives with square male output, in different sizes 1/4", 3/8", 1/2", 5/8", 3/4" and 1".
- Quick Change Adapters for different square drives (3/8", 1/2", and 5/8") with multiple female Hex outputs for bit and nut setter combinations:
 - 1/4" Hex style C
 - 1/4" Hex style E
 - 5/16" Hex style C
 - 7/16" Hex style E



QCAs are often used for bits with input 1/4" Hex drive style C or E .

Optional features

- Guided
- ROTACTION
- Wobble adapters and/or Universal adapters for better accessibility.

Wobble adapters are recommended if you need to reach spaces with difficult accessibility. They manage higher loads compared to universal adapters, because they have a limited angle of 15°, which prevents an incorrect load on the connection between the socket and wobble adapter.



NOTE: Torx®, Torx Plus® are registered trademarks of Acument Intellectual Properties. LLC.

08

Bits and bit holders

There is a wide range of bits to choose from on the market. Whether you need bits for assembling smartphones or for higher torque applications, Saltus has it all.

Bits are often used in combination with a bit holder to allow the bit to adapt to a tool drive that is of a different size or shape than the bit input. We offer an excellent portfolio of high quality bits and bit holders for machine operated tools.



Bit holders, used in conjunction with a bit, can be a cheaper solution than a bit socket (see [Section 7.3](#)). The bit that is worn can be exchanged instead of changing the whole bit socket.



8.1 Bits

Screwdriver bits are most often used in hand-operated tools such as cordless screwdrivers or drill drivers. Bits come in many different output profiles and sizes depending on the type of screw you want to insert. The input drive (sometimes called the 'shank') is the part of the bit that fits into the output drive of the power tool. Most bits have Hex drives, but can also have wing-shank and halfmoon input drives.

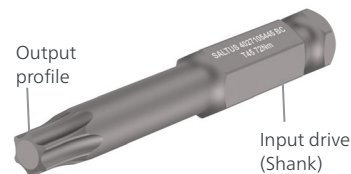

NOTE: Torx®, Torx Plus® are registered trademarks of Acument Intellectual Properties, LLC.

8.1.1 Different bit types

- Different input drives, e.g., wing shank Ø4 mm, halfmoon Ø4 mm and different Hex drive sizes, e.g., 1/4" style C or E, 5/16" style C, 7/16" style E, 11 mm, 16 mm and 22 mm.
- Bits are available in many different output profiles (Hex, Torx®, Torx Plus®, Phillips, Pozidriv, etc).
- Common lengths are 25.4 mm (style C) , 34-35 mm (style C) and 49 mm (style E), but bits are also available in other lengths.

Optional features

- Magnet
- ROTACTION



Most bits come with input drive Hex style C or E. The differences between styles C and E are expressed in the shape of the body of the bit and the connection to the power tool, bit holder, or QCA.

- Hex style C has a small groove on each corner of the Hex form to be able to connect to the power tool, bit holder, or QCA



- Hex style E has a bigger groove on the body of the Hex form to connect to a power tool or a QCA.



NOTE: Torx®, Torx Plus® are registered trademarks of Acument Intellectual Properties, LLC.

8.1.2 Our input drives and output profiles for bits:

Different input standards and measurements for bits:

Wing-shank Ø4 mm drive

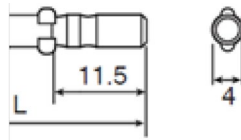

Halfmoon Ø4mm drive

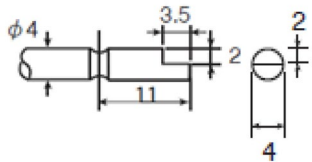

1/4" Hex drive style C

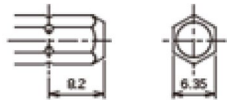

DIN 3126 C6.3
ISO 1173 C6.3

16 mm Hex drive

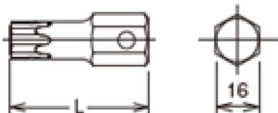

1/4" Hex drive style E

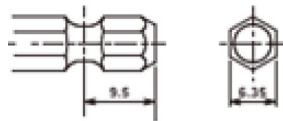

DIN 3126 E6.3
ISO 1173 E6.3

5/16" Hex drive style C



DIN 3126 C8
ISO 1173 C8



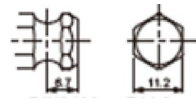





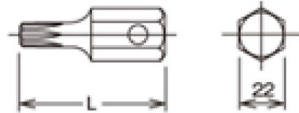















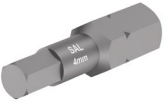

7/16" Hex drive style E



DIN 3126 E11.2
ISO 1173 E11.2

22 mm Hex drive



Input drives for Bits	Output profiles for Bits
 Wing shank Ø4 mm	 Hex, Torx®, Torx Plus®, Phillips, Pozidriv, slotted 
 Halfmoon Ø4 mm	 Hex, Torx®, Torx Plus®, Phillips, Pozidriv, For slotted screws, nut setter (Hex) 
 1/4" Hex drive, Style C	 Hex, Torx®, Torx® (tamper proof), Torx Plus®, Phillips, Pozidriv 
 1/4" Hex drive, Style E	 Hex, Torx®, Torx Plus®, Phillips, Pozidriv, slotted 
 5/16" Hex drive, Style C	 Hex, Torx® 
 7/16" Hex drive, Style E	 Hex, Torx®, XZN 
 11 (7/16") mm Hex drive, Style E	 Hex, Torx®, XZN 
 16 mm Hex drive	 Hex, Torx®, XZN 
 22 mm Hex drive	 Hex, Torx® 

NOTE: Torx®, Torx Plus® are registered trademarks of Acument Intellectual Properties, LLC.

Torx®

The distinctive six-pointed Torx® screw with internal drive is widely used in the electronics and automotive industry, in hard disk drives and assembly of mobile phones. It can be fastened or unfastened with a bit for Torx® screws.

Bits for Torx® screws: output sizes are prefixed with 'T' for example T25, T30, etc. (see appendix A for more sizes).

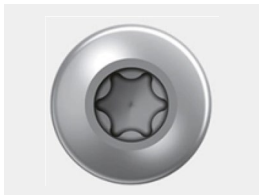

Torx® screw head with internal drive

Torx Plus®

Torx Plus® is an improvement on Torx® screws with a zero-degree drive angle and elliptical-based geometry. Torx Plus® screws can be fastened or unfastened with a bit for Torx Plus® screws.

Bits for Torx Plus® screws: output sizes are prefixed with 'IP' for example 40IP, 45IP, etc. (see Appendix A for more sizes).



Torx Plus® screw head with internal drive

NOTE: Torx®, Torx Plus® are registered trademarks of Acument Intellectual Properties, LLC.

8.2 Bit holders

Bit holders are used between the tool and the bit to allow the bit to adapt to a tool drive that is of a different shape or size. QCAs for bits can also be used for this.



DID YOU KNOW?

QCAs for bits can also be used (see Section 7.7). QCAs are mainly used for bits with input Hex drive style E, but are also available for bits with Hex drive style C.



8.2.1 Different types

- Bit holders can have many different input versions, e.g., halfmoon Ø4 mm, 1/4" Hex drive style E or different input male square drives like 1/4", 3/8", 1/2", 3/4" and 1".
- Bit holders mainly have output Hex, but for different Hex sizes, e.g., 1/4" or 5/16" style C.

Optional features

- Magnet
- Guided
- ROTATION

Bit holders are equipped with a retainer ring that lock the Style C bit onto the bit holder. Bit holders can also be equipped with a magnet that holds the bit in combination with the retainer ring. Bits can also be locked onto the bit holder with a grub screw, though this is often for larger bits.

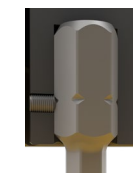

Locking the bit with grub screw



Bit holder with retainer ring

NOTE: Torx®, Torx Plus® are registered trademarks of Acument Intellectual Properties, LLC.

8.2.2 Our selection of bit holders:

Bit holders - input drives	Bit holders - output drives and features
 Halfmoon Ø4 mm	 For 1/4" Hex style C, with magnet 
 1/4" Hex drive style E	 For Wing Shank Ø4 mm 
 1/4" Hex drive style E	 For 1/4" Hex style C with retainer ring -Magnet -Magnet, ROTACTION 
 1/4" square drive	 For 1/4" Hex style C with retainer ring -Magnet -ROTACTION -Magnet, ROTACTION 
 3/8" square drive	 For 1/4" and 5/16" Hex style C with retainer ring -Magnet -ROTACTION -Magnet, ROTACTION 
	For 11 mm Hex -ROTACTION -Guided 

Bit holders - input drive	Bit holders - output drives and features
 1/2" square drive	 For 1/4" and 5/16" Hex style C with retainer ring -Magnet -ROTACTION -Magnet, ROTACTION 
	For 11 mm Hex -ROTACTION -Guided 
 3/4" square drive	 For 16 mm Hex -ROTACTION -Guided 
 1" square drive	 For 22 mm Hex 

NOTE: Torx®, Torx Plus® are registered trademarks of Acument Intellectual Properties, LLC.

NOTE: Torx®, Torx Plus® are registered trademarks of Acument Intellectual Properties, LLC.

09

Hold and Drive solutions

A Hold and Drive (HAD) power tool holds the screw while tightening the nut. HAD screws are used, for example, by truck manufacturers on the frame assembly line, making what used to be a two-man operation, a one-man task.



9.1 Examples and principle

HAD systems are required in those cases where it is neither possible nor convenient to hold the screw from the opposite side of a threaded end while tightening. In the next part you will see an example of this when securing a shock absorber; here, assembly does not seem possible in any other way than with an HAD tool.

9.1.1 Examples of HAD applications

HAD is typically used in securing the shock absorber rod to the car body. During tightening, there is no other way of preventing the rod from rotating freely in the shock absorber cylinder than by gripping the threaded end through the hexagonal socket used for tightening. For this reason, the rod end is designed with a key grip of some kind.

Other HAD applications are in the area of ball joints and suspension parts. Hold-and-drive tooling is especially prevalent in the aerospace sector.



9.1.2 Tightening principle

Manual tightening principle

You can use a hand wrench and key to tighten in cases where it is difficult or impossible to hold the screw/bolt from the opposite end. As shown in the picture to the right, you will need to manually hold the end of the screw with a key and tighten the nut with a hand wrench.



HAD tightening principle for angle head power tools

The HAD tightening principle explained below is used with an angle head power tool.

The screw holder is always fixed and does not turn. It is the socket that moves and tightens the nut. This is why the tools are called 'Hold-and-Drive'.

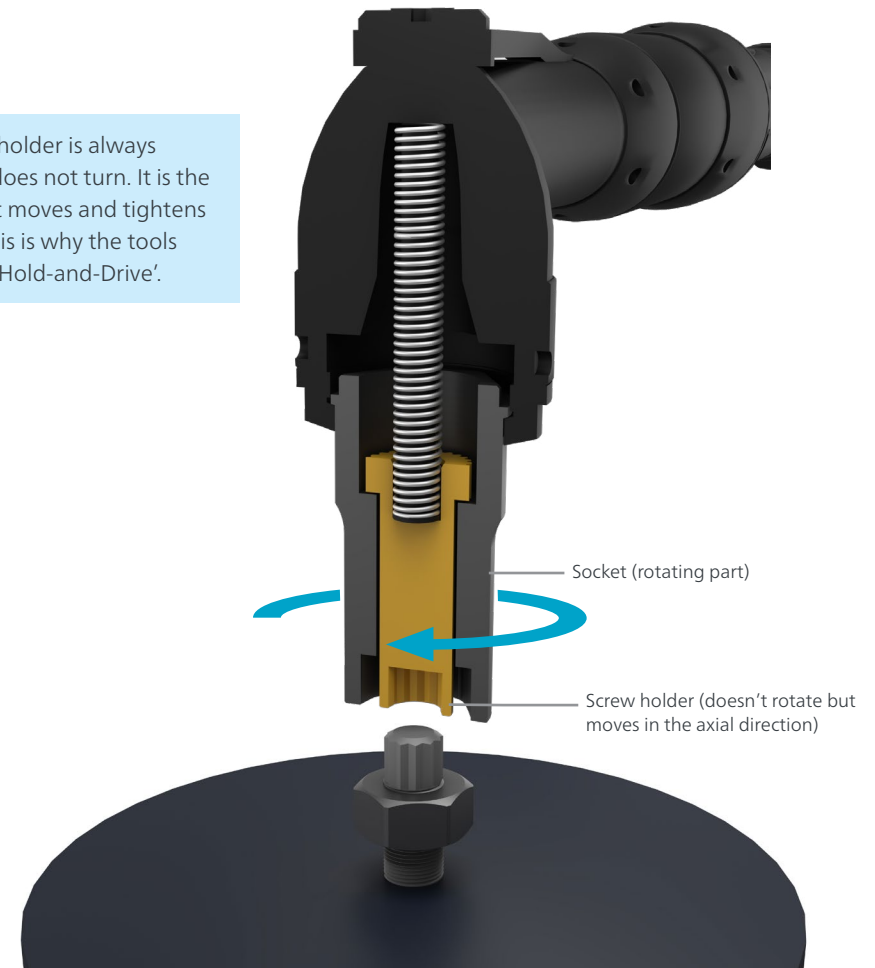

If you want to use a power tool for the above operation, it calls for special tools which will allow a **screw holder** (see the yellow part above) inside the socket to hold the tip of the screw while tightening is being performed. The screw holder is always fixed. However, it is able to move axially to make room for the threaded part of the screw, while the socket follows the nut running down.

The **socket** (sometimes called drive socket or nut socket) is the part that turns and tightens the nut to the final torque. The socket is connected to the output gear of the tool.

9.2 Sockets, screw holders, bit holders and bits for HAD angle head power tools

Sockets, screw holders, bit holders and bits for HAD angle head power tools come in different sizes and models to meet the different specifications of the screw tip and the nut. You can find a standard range of sockets, screw holders and bit holders for HAD angle head power tools in the Atlas Copco catalog *Industrial Tools and Solutions* in the section "Optional Accessories for Hold and Drive tools".

9.2.1 Sockets for HAD angle head power tools

As explained in [Section 9.1.2](#), the socket is the part that turns and tightens the nut to the final torque. The socket is connected to the output gear of the tool. HAD sockets come in different sizes and models to meet different nut specifications.

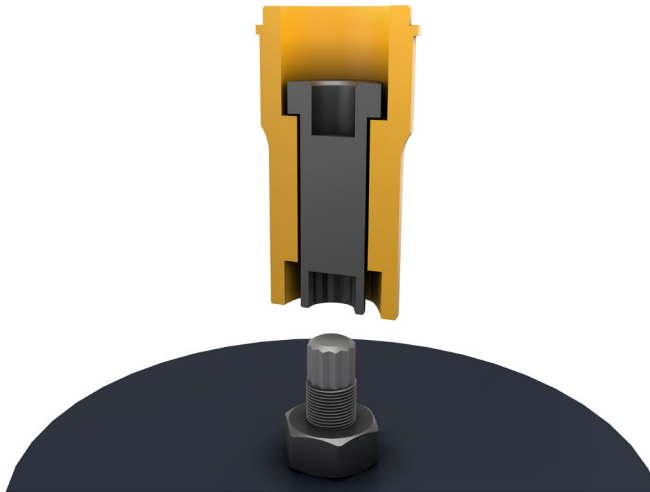

Socket outputs

HAD sockets can have different output profiles, such as Surface Drive (which is standard), Hex, Double Hex and Torx®. These can also be supplied on request.



NOTE: Torx®, Torx Plus® are registered trademarks of Acument Intellectual Properties. LLC.

Surface drive socket

Generally, it is an advantage to select a surface drive socket for both the drive socket and the screw holder socket where applicable. The reason is that the surface socket offers easier engagement between socket and hexagon nut and screw tip. This is especially applicable to HAD applications where both drive socket and holder must mate before tightening begins.

Another advantage is that the surface drive socket reduces the risk of residual forces between socket and holder, that might lock the tool to the joint.



Female Surface Drive

What holds it together

The sockets for HAD tools have a flange on the upper part of the socket and a nut which connects the socket to the power tool.

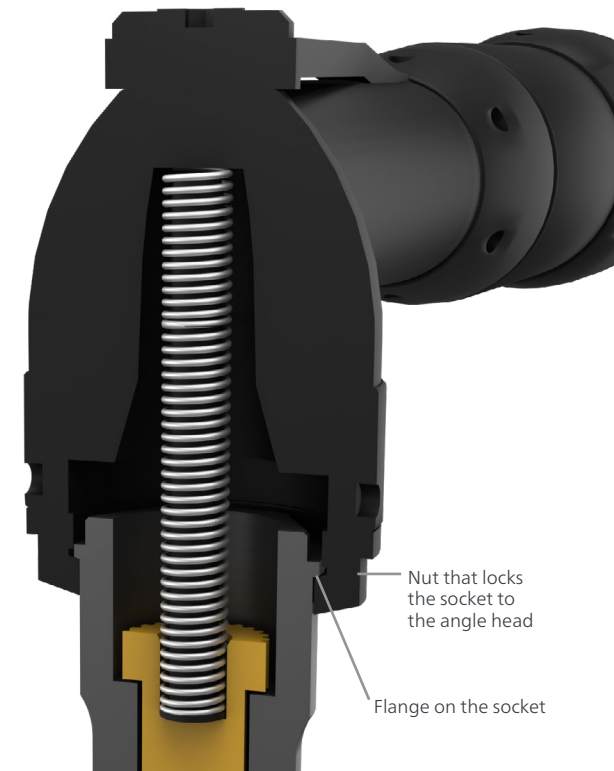

Nut that locks the socket to the angle head

Flange on the socket

9.2.2 Bit holders for HAD angle head power tools

The bit holder with the bit, is the part that holds the tip of the screw while tightening.

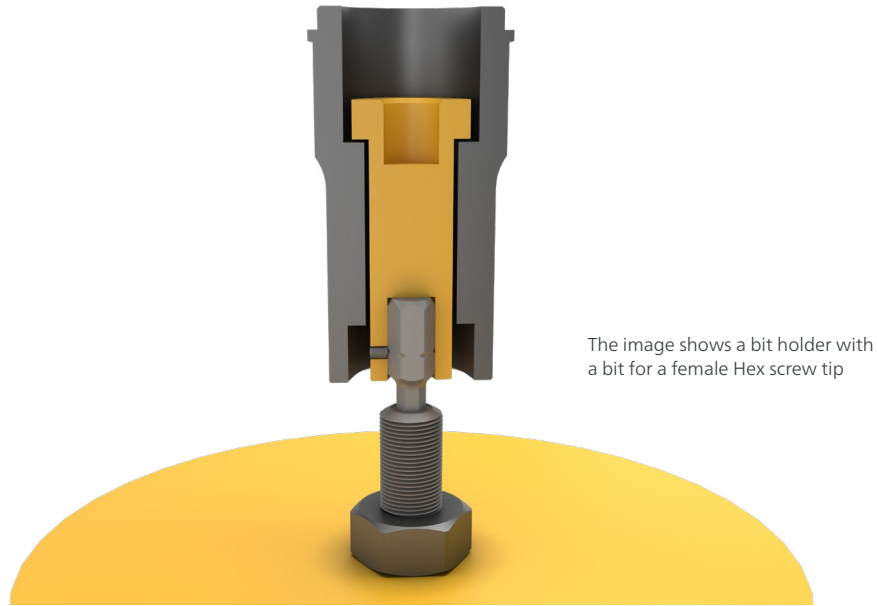

Bit holders for HAD can come with different output sizes to fit different inputs for bits. 1/4" and 5/6" Hex style C bits are the most common output sizes for bit holders. If you use a bit holder, then a bit must be used.



9.2.3 Bits for HAD

Bits can be delivered with different output profiles like male Hex and Torx® in different sizes. The most common input sizes for bits are 1/4" (L=25.4 mm) and 5/16" (L=34-35 mm) Hex drive, style C. You can find a range of standard bits that can be used for HAD applications in the Saltus catalog, [Sockets and Bits for Industrial Power Tools](#).



Male Hex



Male Torx®



Locking with spring pin



Locking with grub screw

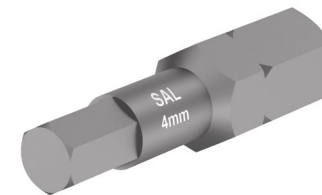

Fixing of bit to the bit holder

- Bits for our smallest range of HAD tools (50 Nm) are locked to the bit holder with a spring pin.
- Bits for all other HAD tools, e.g., 100 Nm, 200 Nm, 370 Nm and 600 Nm, are locked to the bit holder with a grub screw.

NOTE: Torx®, Torx Plus® are registered trademarks of Acument Intellectual Properties, LLC.

9.2.4 Screw holders for HAD angle head power tools

As explained in [Section 9.1.2](#), the screw holder is the part that holds the tip of the screw while tightening.

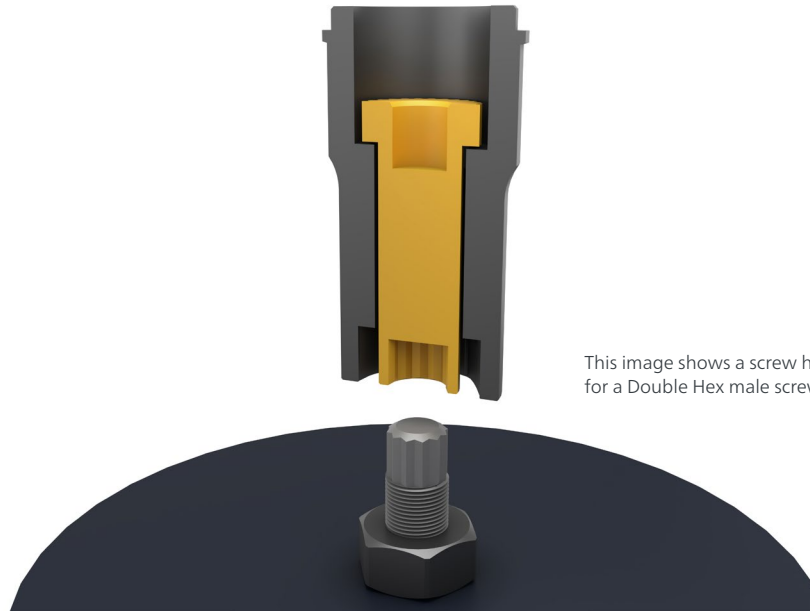

This image shows a screw holder for a Double Hex male screw tip.

The **screw holder** can have different output profiles, including Hex, surface drive, Double Hex, Torx®, or Two Flat, depending on which screw tip needs to be held.



Female Hex



Female Surface Drive



Female Double Hex



Female Torx



Female Two flat

NOTE: Torx®, Torx Plus® are registered trademarks of Acument Intellectual Properties. LLC.

9.2.5 Best practices for standard HAD power tools

Atlas Copco has standard HAD power tools up to 600 Nm. There are five different standard interfaces depending on the torque level and angle head. The different interfaces are defined based on the different maximum torque levels that the angle head can be used for.

The different HAD interfaces are: 50 Nm, 100 Nm, 200 Nm, 370 Nm, and 600 Nm. For example if you have a tool that is specified for a maximum torque of 30 Nm, then you should use interface 50 Nm. If you have a tool that is specified for a maximum torque of 180 Nm, then you should use interface 200 Nm.

The heads can be connected to both pneumatic and electric tools. In [Sections 9.2.5.1 to 9.2.5.3](#), we highlight the most important points to keep in mind when selecting a standard HAD solution from Saltus.

Example of HAD standard angle heads



50 Nm



100 Nm



200 Nm



370 Nm



600 Nm



Example of assembled HAD for power tools

9.2.5.1 Length of HAD sockets, screw holders and bit holders

HAD sockets, screw holders and bit holders are available in standard lengths and dimensions. You can find this standard range in the Atlas Copco catalog *Industrial Tools and Solutions*, under the heading "Optional Accessories for Hold and Drive tools".

There are **three different standard lengths available for HAD solutions: 33 mm, 53 mm and 73 mm**. This is how far the socket extends outside the angle head. The socket extension is measured from the bottom of the nut to the end of the socket.



Socket Extension A



Socket Extension B



Socket Extension C

The Socket Extension length (A,B or C) is the most important measurement when configuring a standard HAD solution. Based on this length you can configure a complete HAD solution. HAD solutions can also be customized and supplied in special lengths on demand.

9.2.5.2 Travel for screw holder

The maximum travel for most HAD angle head power tools is 30 mm. Tools with 40 mm travel also exist.

The necessary screw holder travel is determined by the screw's protrusion from the joint, after tightening. See the maximum protrusion in the end position picture below. If the protrusion is longer than the standard screw travel (30 mm or 40 mm) then a customized HAD solution will be needed.

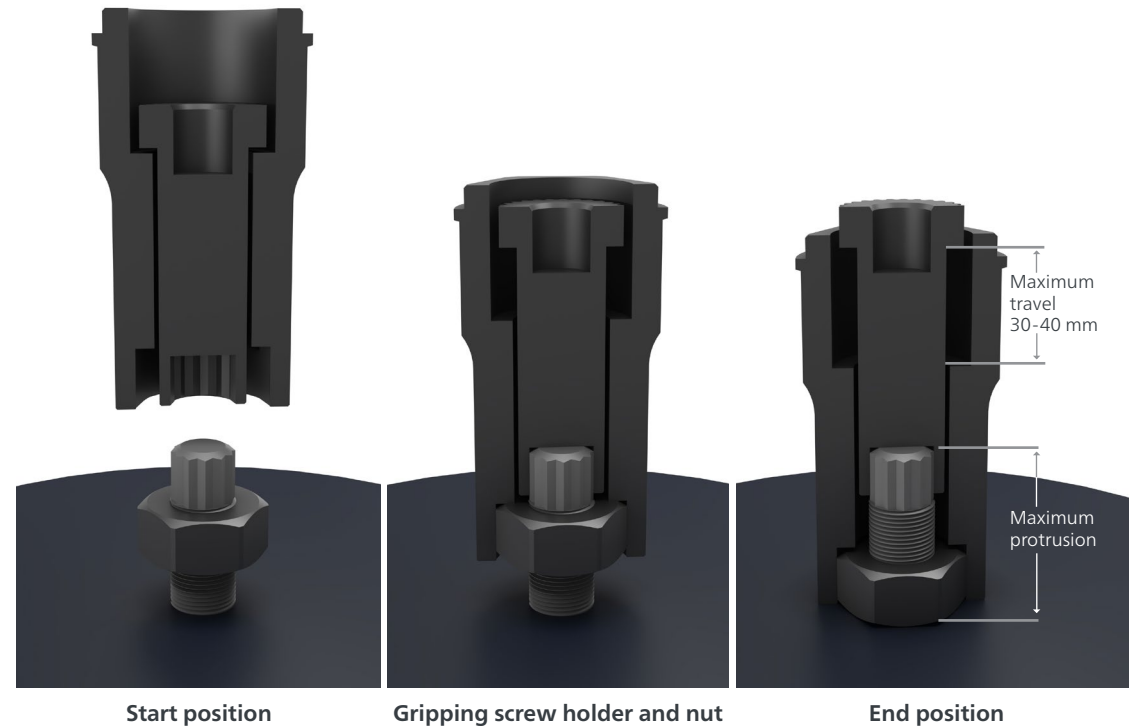

DID YOU KNOW?

In order to ensure full grip of the holder, it is important for the nut to be securely fastened on the screw before you start tightening with the HAD power tool.

NOTE: You will rarely need more than 30 mm travel. The maximum protrusion of the screw is measured from the base of the nut when it is completely tightened.

9.2.5.3 Extension of the screw holder¹

The extension of the screw holder (E in the picture) refers to how much the screw holder extends from the HAD socket. A certain amount of extension of the screw holder from the HAD socket makes it easier to grip the tip of the screw; it allows the operator to see the screw holder and the tip of the screw.

Normally the screw holder protrudes in the range of 0-5 mm for Saltus standard HAD solutions.

The extension of the screw holder has a negative impact on travel length. If travel is critical, the screw holder may have to be recessed (negative extension) in the socket.



9.2.6 HAD Quick Change solutions for angle head power tools

For some assembly situations a specially designed or customized solution can further improve process efficiency. An example of this is Quick Change solutions for HAD socket/bit combinations. Quick Change solutions can serve two joints with different socket/bit combinations using only one power tool. A Quick Change base unit (A) is mounted permanently on an Atlas Copco ETV HAD tool. On top of this base unit, different change sockets (B) can be mounted. The change socket (B) has an integrated Quick Change coupling and can be fixed on and removed easily from the base unit. A bit holder which takes the bit (C) is integrated into the change socket as well.

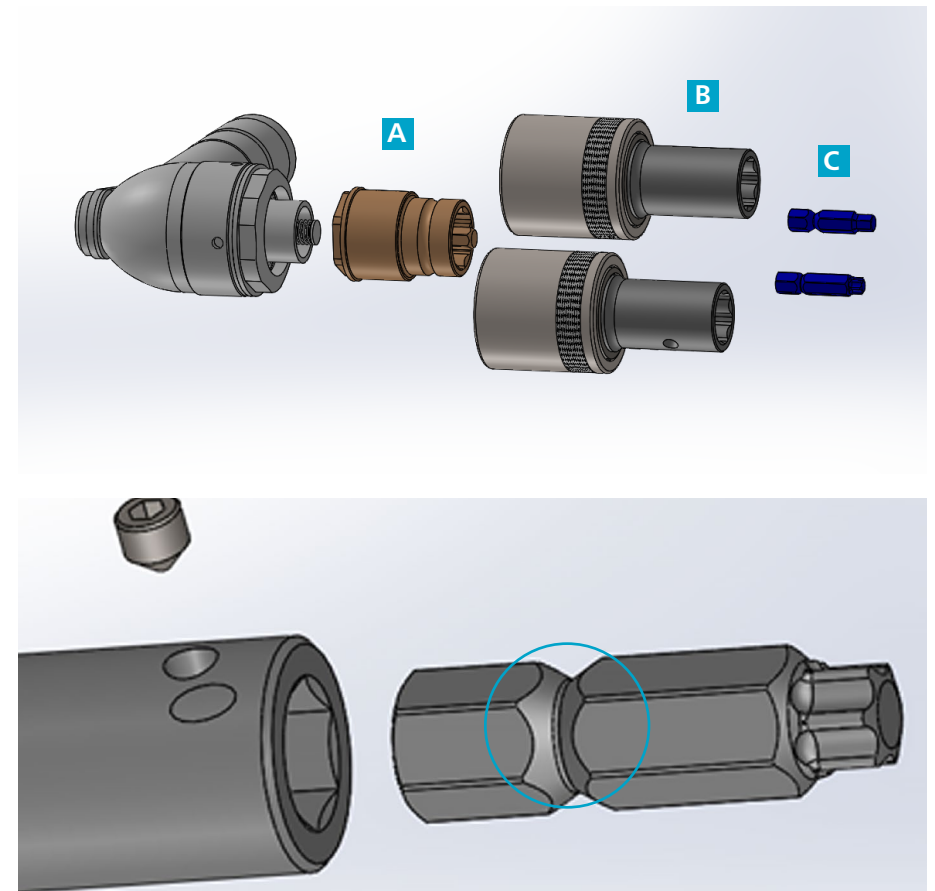

¹The same applies if a bit is used to hold the tip of the screw

9.2.7 Special HAD angle head power tools

If you cannot find a HAD solution in our standard range, then you need to have a customized solution which we can make on special request. For example you might need a longer socket, longer travel or another output profile for the holder or the socket. To get the best solution, you will need to share information about the tightening application. The pictures here show two typical screw joints. The first shows one with a **male screw tip** and the second with a **female screw tip**. A **few important measurements** are needed in order to define the special HAD solution:

1. Tool and tightening torque

HAD torque: 50 Nm, 100 Nm, 200 Nm, 370 Nm or 600 Nm

2. The nut

- Nut size (for example: across flat 13 mm)
- Nut height

3. The screw

3a. Male screw tip

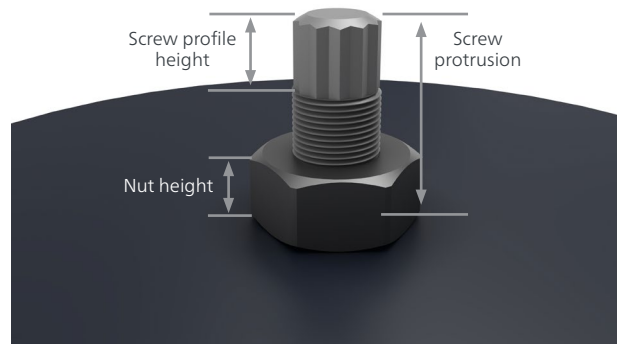

- Screw profile and size, for example: Double Hex 6 mm



Male Hex



Male Double Hexagon



Male Two Flats



Male Torx®

- Screw profile height, for example, 8 mm
- Screw protrusion, for example, 25 mm

NOTE: Torx®, Torx Plus® are registered trademarks of Acument Intellectual Properties, LLC.

3b. Female screw tip

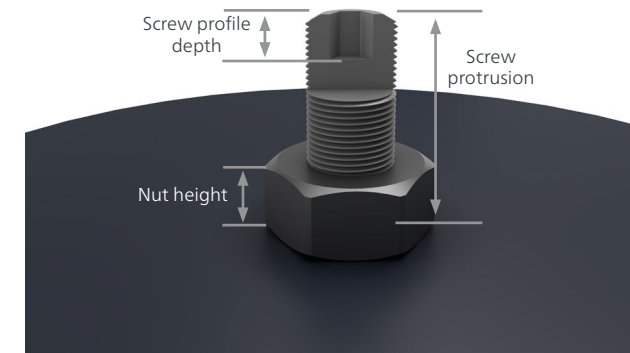

- Screw profile and size, for example, female Hex 5 mm



Female Hex



Female Torx®

- Screw profile depth, for example, 8 mm
- Screw protrusion, for example, 25 mm

NOTE: Make sure to define the measurements only when the screw-joint is fully tightened.

4. Socket and holder

- Socket extension from tool
- Holder or bit extended/recessed (E) from the socket (see [Section 9.2.5.3](#))
- Socket outer diameter (D)
- Holder outer diameter (d)

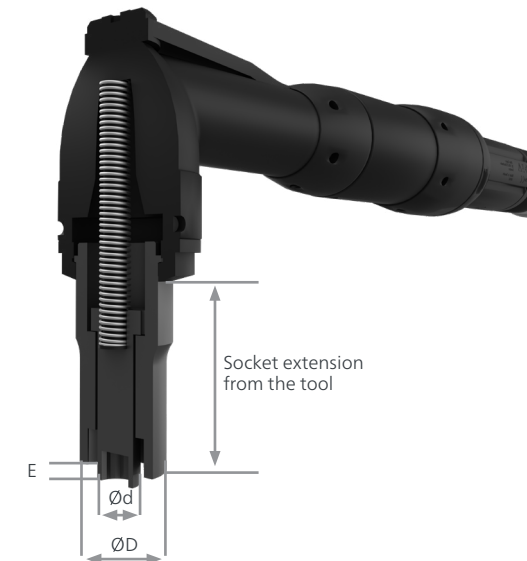

NOTE: Torx®, Torx Plus® are registered trademarks of Acument Intellectual Properties, LLC.

9.3 Reaction-free HAD power tools¹

Atlas Copco has developed a new generation of reaction-free HAD power tools for a safer and more ergonomic work environment. These tools are commonly pistol type but can also be angle head tools. Saltus has matching HAD sockets, screw holders, bit holders and bits for reaction-free HAD power tools.



9.3.1 Tightening principle for reaction-free HAD power tools

In reaction-free HAD tools, both the screw holder and socket rotate. During the rundown phase, the screw holder rotates the screw counter clockwise, pulling it towards the tool, while the socket remains stationary.

When it has reached the tightening phase, the opposite is true; the socket rotates clockwise while the screw holder remains stationary, acting as the reaction arm.

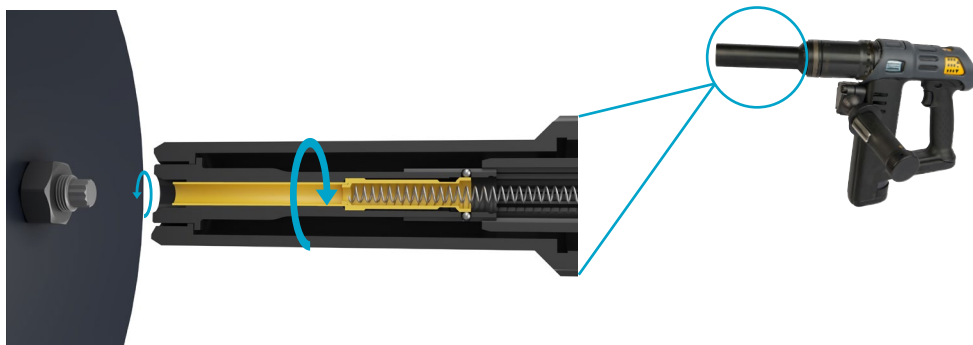

¹ In reality, reaction-free HAD power tools do cause a small reaction torque. This is caused by the motor driving the tool. However, the force is negligible and will not disturb the operator.

For reaction-free HAD power tools, the full reaction torque is taken internally by the screw holder and transferred to the screw tip. Therefore, both the screw tip and the screw holder must be designed to manage a high level of reaction torque.

For a durable reaction-free HAD tool solution, a male Torx® or Double Hex screw tip is needed. A male Two Flat is (most likely) not enough to manage this level of reaction torque. Neither is a bit or bit holder durable enough for reaction-free HAD applications.

A bit is not strong enough to hold the screw tip in applications where reaction free tools are used. A male Torx® or Double Hex screw tip will be required.

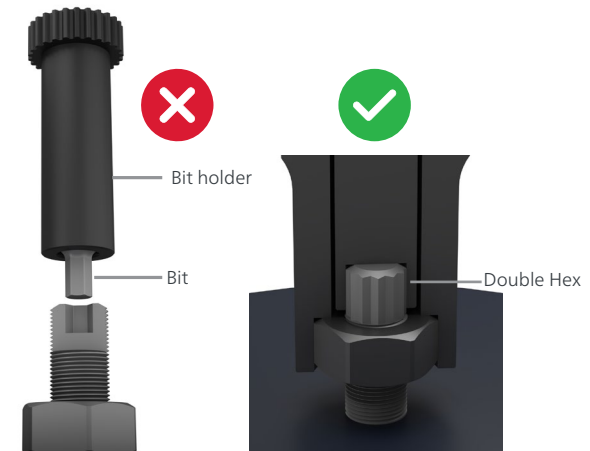

An example

Below you can see two examples of HAD screw tips: Two Flat and Double Hex. The Two Flat screw can only be used for HAD power tools where the reaction force is taken up by the tool and the operator (see [Section 9.2.3](#) through to [Section 9.2.6](#)). It must be noted that when you use a reaction-free HAD power tool you must use a screw with a more durable tip profile like a Torx® or Double Hex.

The advantages of this reaction-free HAD system become apparent when taking into consideration the ergonomic factors of high torque applications.



Two Flat screws should not be used for reaction-free HAD power tools

For reaction-free HAD power tools, use a screw tip that can better distribute the force, like a Torx® or Double Hex

NOTE: Torx®, Torx Plus® are registered trademarks of Acument Intellectual Properties, LLC.

9.3.2 Full Engagement Device (FED)

To improve the durability of the screw holder, all reaction-free HAD screw holders are equipped with an FED. This ensures that the screw holder fully grips the screw tip before tightening starts.

As stated previously, the full reaction force is applied to the screw holder. Without full grip of the screw tip, there is a high risk of screw holder or screw tip breakage.

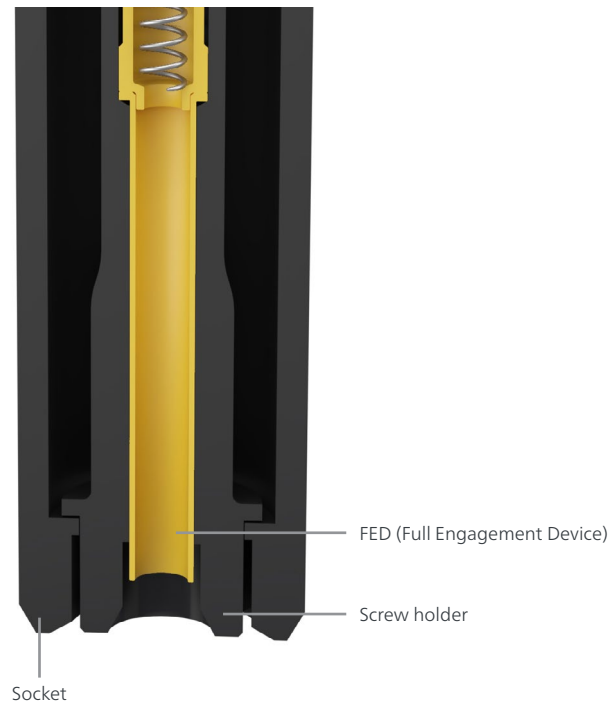

The FED prevents the screw holder from moving more than a few mm axially until it has been pushed in by the screw tip. Only after the FED has been fully pushed in can the screw holder travel enough for the outer socket and nut to mate.

If the screw or screw holder breaks, the operator will not be subjected to any reaction force; the tool will just spin internally.

9.3.3 Examples of reaction-free HAD tools

Reaction-free HAD tools are available in pneumatic, electric, pistol and angle head versions of power tools.

Pistol grip tools



Pneumatic (LTP)



Electric (Revo)

Angle head tools



Pneumatic (LTV)



Electric (ETV)

9.4 Reaction torque

When using any power tool you have to contend with a counter reaction force. When the reaction force is manageable, it can be handled physically by the operator. When it is higher, a reaction bar will be needed to absorb the force. Also when using tools with HAD, this reaction force has to be handled in exactly the same way as you would any power tool.

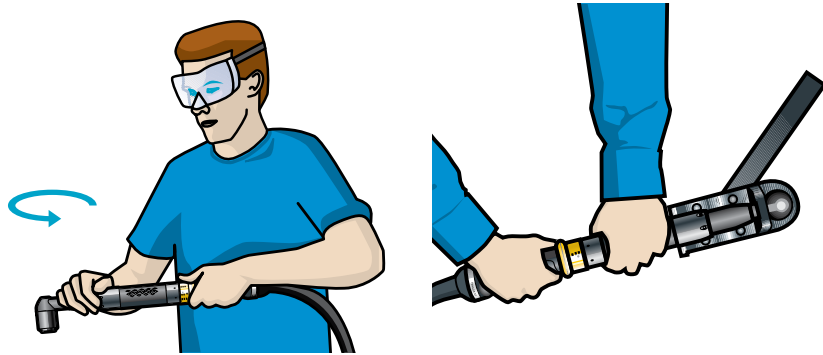

DID YOU KNOW?

With HAD power tools, it is extra important to properly manage the reaction force. This is because when the full force of the torque travels through the screw tip and the screw holder, it could result in breakage of the screw tip or the screw holder. If you do not properly manage the reaction force with a reaction bar or manually, the screw tip and the screw holder will have to bear the entire reaction force.



You should never let go of the tool during operation. This is because breakage of the screw tip or the holder could result in an immediate torque reaction which could cause injury unless the tool is safely secured from turning around.



These photos show an unused and a broken Two Flat screw tip

9.4.1 Friction clutch

For cases where the reaction force cannot be completely absorbed by a reaction bar or the operator, we have developed a friction clutch that will release the holder as soon as a certain applied torque value has been reached. This threshold torque value can be pre-adjusted in the clutch (normally between 15 Nm and 30 Nm). We can offer the friction clutch for HAD interfaces 100 Nm, 200 Nm and 370 Nm. The threshold torque value is normally set to between 10 Nm and 50 Nm depending on the HAD interface you are using.

This friction clutch device will decrease the risk of holder or bit breakage. Furthermore, it will reduce the risk to the operator from any unexpected reaction force in the event of breakage.

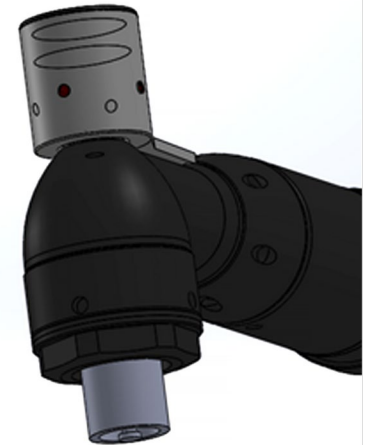

Breakage of the screw tip or the screw holder is a matter of material consumption and also a safety risk.

10

Proper use of sockets and bits

In order to maximize the lifespan of sockets and bits, it is important to use them correctly as they are subject to regular wear. Depending on the quality and duration of use, they need to be replaced on a regular basis. In the coming sections we explain the factors that have a significant impact on the lifespan of sockets and bits.

10.1 Use sockets and bits with correct applied torque for the tightening application

- The applied torque affects the lifespan of sockets and bits. The higher the torque, the shorter the lifespan.
- Standard sockets are manufactured according to DIN 3121/3129. Minimum test torsion torques are defined within these norms.
- We recommend a continuous working load not higher than 70% of the test torque for standard sockets and bits. This maximum recommended torque level is documented on applicable standard sockets and bits in the Saltus catalog [Sockets and Bits for Industrial Power Tools](#).
- The maximum recommended torque level is also marked on the applicable Saltus standard sockets and bits.

10.2 Side forces on the sockets and bits

Side forces are caused, for example, by pulling a wheel assembly fixture along the assembly line. The sockets and bits are the link between the moving vehicle in a conveyor which pulls the wheel assembly fixture. This fixture, including telescopic suspension and rail systems, can easily weigh 300 kg or more.

This additional load on the socket needs to be considered in the design of the entire tightening system.



Surface drive socket for wheel nut runner, with fixed protection sleeve

10.3 Misalignment of the socket/bit and the screw/bolt axis

It is important that the socket or bit grips straight against the screw when tightening. Anything other than straight will create wear and result in rounded square drives, rounded hexagonal profiles. It could even result in breakage.

When pulling out the socket or bit from the fastener, it is important to hold the tool straight to prevent it from acting as a lever, which would cause the socket or bit to crack due to the excessive bending force.

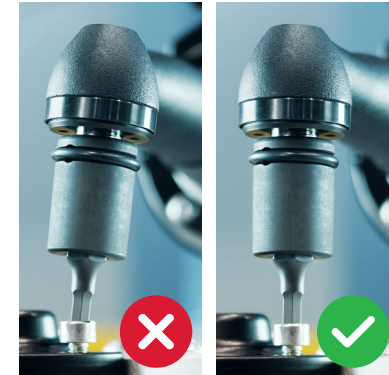

10.4 Gripping the screw/bolt

When tightening, sockets and bits must grip the bolt/screw to its full length. Partial grip without lowered torque could result in broken sockets/bits as a result of the force being distributed over a smaller area.

The picture to the right shows a Torx® 30 bit fully gripping the screw, which optimally distributes the forces over the bit. A Torx® 30 bit is designed to manage a maximum torque of 26 Nm under continuous workload. But if only a small part of the tip grips the screw, then the force applied to the tip of the bit may cause it to break.



Sockets and bits must grip the bolt/screw to its full gripping area; partial grip without lowered torque, can result in broken bits.

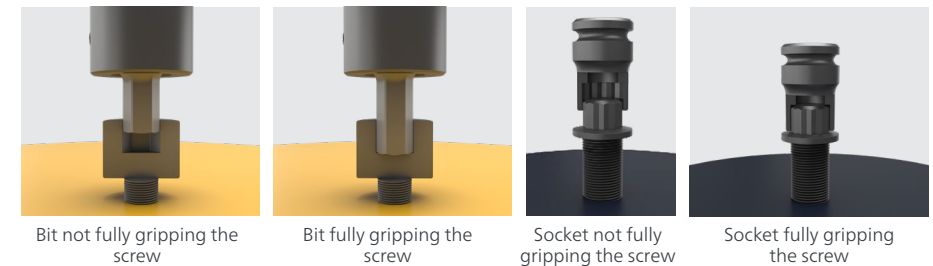

When fastening the screw, it is very important that the socket/bit remains stationary. The tool must be stopped before fastening the screw. If not, the socket/bit may break, or wear out earlier than normal. There are sockets that allow for the screw to be fastened with a rotating tool, like a lead in chamfer (see [Section 7.2.3](#)).

NOTE: Torx®, Torx Plus® are registered trademarks of Acument Intellectual Properties, LLC.

11

Best practices

11.1 Scenarios

Below are examples of sockets and bits being used wrongly in specific scenarios. We recommended the preferred approaches to the right.

SCENARIO 1: NOT RECOMMENDED

The welded socket combination



In production lines, sometimes sockets are welded together. This is dangerous as high torque levels can cause a sudden crack in the welding. This puts the well-being of the operator at risk and can damage the assembled part. If the operator isn't using safety goggles, fragments could harm their eyes.

In the picture, you see an example of a socket for hand-operated tools that has been welded together with an impact socket.

Disadvantages

- Can be dangerous; any breakage can injure the operator
- Fragments can cause eye injuries
- Hard to specify maximum torque
- Sockets for hand-operated tools are less durable
- Hard to get it axially straight
- Hard to find spare parts

SCENARIO 2: NOT RECOMMENDED

Adapters used wrongly



Sometimes you need adapters (for example, a QCA to change a socket or change the drive size from 1/4" to 3/8" to fit a certain socket). In the picture shows a suboptimal solution made up of three different parts: a QCA, adapter, and socket. This solution builds up a tolerance chain that will result in considerable room which will cause the socket to wobble. This will increase the wear, and shorten the lifetime for both the power tool and the socket. It will also lead to deteriorated power transmission due to torque losses.

Disadvantages

- Unsafe; risk of entanglement
- Increased wobbling due to several connections
- Poor torque transfer
- Use of a chrome socket with a hand operated tool will reduce the lifespan of the socket

SOLUTION 1: RECOMMENDED

We recommend two alternatives



1. Check if a standard ROTACTION socket for power tools (which fits the customer's needs) exists in the Saltus standard range.
- OR
2. Request a customized socket for power tools that is one solid piece that matches the customer's specifications. ROTACTION is always preferred for the safety of the operators.

Advantages

- Withstands higher maximum torque
- Longer lifespan
- Straight socket
- Not dependent on skill
- Spare parts easily available
- Less risk of entanglement, if supplied with ROTACTION

SOLUTION 2: RECOMMENDED

Use a standard ROTACTION QCA with a ROTACTION socket



If needed, request special ROTACTION socket.

Advantages

- Safer; less risk of entanglement
- Less wobbling due to fewer connections
- Less wear on tool and socket
- Better torque transfer
- Use of sockets for power tools

Unguided socket and extension without ROTACTION on a power tool



Sockets are often extended with an extension, causing an additional clearance safety risk and a wobbling which consumes torque that ought to be applied to the bolt. When the operator touches the adapter or extension, friction torque is transferred to the operator's hand causing an insufficient torque.

Disadvantages

- Unsafe; risk of entanglement
- Excessive play (clearance) results in increased wear and torque loss
- Poor ergonomics results in wobbling and vibrations
- Vibrations cause wear on tool and socket

Different angled extensions and adapters



As shown in the image, some situations are hard to solve with standard articles and the tendency is to combine whatever is at hand. Here we see an unsafe combination of **four different articles: adapter, extension, adapter, socket.**

Disadvantages

- Unsafe; risk of entanglement
- Excessive play (clearance) due to use of several components
- Torque loss

Advice: A polished socket is a good indication that the operator likely holds the socket with their hands, possibly while using gloves. This is very unsafe!

Use a standard guided ROTACTION extension in combination with a guided ROTACTION socket (See Section 4.2.1). You may request a customized solution.

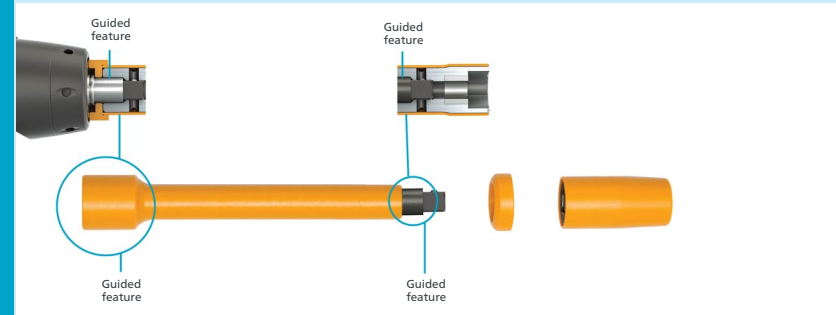

Advantages

- Less wobbling due to fewer connections
- Better torque transfer
- Less risk of entanglement

Use a two-piece solution with a standard ROTACTION extension and a special ROTACTION socket



Advantages

- Less wobbling due to fewer connections
- Better torque transfer
- Less risk of entanglement

Solution with cardanic joint



Some situations pose accessibility challenges. That's when you need to use a cardanic joint/socket as shown in the picture here. However, these sockets often break because the force applied is usually at a large angle.

Disadvantages

- Applying higher torque at a large angle can cause a cardanic joint to break which could injure the operator and damage the assembled part
- Use of chrome sockets intended for hand-operated tools will shorten the lifespan of the socket
- The surface treatment is not durable enough and sometimes chrome fragments fly out

Using a standard wobble adapter in combination with a standard socket, extension and QCA



Advice: Wobble adapters and extensions can be customized as one single piece, to decrease movement and wobble even further. In some cases wobbling is a desired feature as more wobbling can lead to better access. Our first priority however is to avoid wobbling, but if it is requested by the customer, we can provide the right solution.



Advantages

- The wobble adapter has a limited angle of approximately 15° which prevents excessive load on the cardanic joint
- Sockets for power tools will have greater durability



The extension should come as a wobble adapter at the end of the extension.

Appendix

A Dimensions for Torx®/Torx Plus®, XZN bits and Torx®/Torx Plus® sockets

Torx® bits		Torx Plus® bits		S1 (mm)	S2 (mm)
		S1	S2		
T6	6IP	1.7	1.2		
T7	7IP	2.0	1.4		
T8	8IP	2.3	1.7		
T9	9IP	2.5	1.8		
T10	10IP	2.7	2.0		
T15	15IP	3.3	2.3		
T20	20IP	3.9	2.8		
T25	25IP	4.5	3.2		
T27	27IP	5.0	3.6		
T30	30IP	5.6	4.0		
T40	40IP	6.7	4.8		
T45	45IP	7.9	5.6		
T50	50IP	8.9	6.2		
T55	55IP	11.3	8.0		
T60	60IP	13.3	9.5		
T70	70IP	15.6	11.1		
T80	80IP	17.6	12.7		
T90	90IP	20.0	14.2		
T100	100IP	22.2	15.8		

XZN bits		
	S1 (mm)	S2 (mm)
04	3.6	3.1
05	4.8	4.1
06	6.1	5.1
08	7.3	6.1
10	9.7	8.1
12	11.5	9.7
14	13.3	11.2
16	15.7	13.2
18	16.9	14.2

Torx® sockets		Torx Plus® sockets		S1 (mm)	S2 (mm)
		S1	S2		
E4	4EPL	3.7	2.7		
E5	5EPL	4.6	3.3		
E6	6EPL	5.6	4.0		
E7	7EPL	6.1	4.3		
E8	8EPL	7.4	5.3		
E10	10EPL	9.3	6.8		
E11	11EPL	9.3	7.1		
E12	12EPL	11.0	7.9		
E14	14EPL	12.8	9.2		
E16	16EPL	14.6	10.5		
E18	18EPL	16.5	11.9		
E20	20EPL	18.3	13.2		
E22	22EPL	20.1	14.8		
E24	24EPL	22.0	15.7		
E26	26EPL	23.7	17.5		
E28	28EPL	25.5	18.3		
E30	30EPL	27.3	20.0		
E32	32EPL	29.0	21.3		

*Tamper proof

NOTE: Torx®, Torx Plus® are registered trademarks of Acument Intellectual Properties. LLC.

B Socket and bit sizing chart

Screw dimension (mm)	Standard Hexagon head screw (mm) (other sizes may occur)	Standard Hexagon head cap screw (mm) (other sizes may occur)	Torx® head screw	Torx® head cap screw	Torx Plus® head screw	Torx Plus® head cap screw	XZN head cap screw	Standard tightening torque (Nm)		
								Grade 8.8	Grade 10.9	Grade 12.9
M2	4	1.5		T6/T8		6IP		0.32	0.45	0.54
M2.5	5	2		T8		8IP	03	0.65	0.92	1.1
M3	5.5	2.5	E4	T10	4EPL	8IP/10IP	03	1.16	1.63	1.96
M3.5	(6)			T15		10IP/15IP		1.82	2.56	3.08
M4	7	3	E5	T20/T25	5EPL	15IP/20IP	04	2.7	3.79	4.54
M5	8	4	E6	T25/T27	6EPL [8EPL]	20IP/25IP/27IP	05	5.47	7.67	9.18
M6	10	5	E8	T30	8EPL [10EPL]	27IP/30IP	06	9.27	13	15.6
M7	11		E8	T40	8EPL [12EPL]	40IP		15.5	21.8	26.2
M8	13	6	E10	T40/T45	10EPL [14EPL]	40IP/45IP	08	22.5	31.6	37.9
M10	16 (17)	8	E12	T50	12EPL [16EPL]	45IP/50IP	10	44.5	62.6	75.2
M12	18 (19)	10	E14	T55	14EPL [20EPL]	55IP	12	77.6	109	131
M14	21 (22)	12	E14/E18	T55/T60	18EPL [24EPL]	55IP/60IP	14	124	174	209
M16	24	14	E16/20	T60/T70	20EPL [26EPL]	60IP/70IP	16	194	271	325
M18	27	(14)	E24	T70/T80	24EPL [30EPL]	80IP	18	266	373	447
M20	30 (32)	17	E24	T80/T90	24EPL [32EPL]	90IP		376	529	635
M22	32	(17)	E28	T90/T100	24EPL [36EPL]	100IP		511	720	865
M24	36 (38)	19	E32	T100	32EPL [40EPL]	100IP		650	915	1100
M27	41	(19)	E32		32EPL			961	1340	1610
M30	46	22	E36		36EPL			1290	1820	2180
M33	50	(24)	E40		40EPL			1760	2470	2970
M36	55 (54)	27	E44		44EPL			2260	3180	3810
M39	60	(27)						2920	4110	4930
M42	65	32						3610	5080	6080
M45	70	(32)						4540	6370	7630
M48	75	36						5440	7620	9120
M52	80	(36)						7040	9880	11800
M56	85	41						8710	12300	14800
M60	90							10900	15300	18300
M64	95	46						13100	18500	22300
M68	(100)							16000	22500	27000

The dimensions in the socket and bit sizing chart are based on common standards. The torque values are recommendations based on the screw grade and size. Please contact Saltus Competence Center for more information.

NOTE: Torx®, Torx Plus® are registered trademarks of Acument Intellectual Properties. LLC.

Assembly tools for screws and nuts

- ISO 1174 / DIN 3121 Driving squares
- ISO 2725 /DIN 3129 Square drive sockets
- ISO 1173 / DIN 3126
Hexagon styles - Drive ends for hand and machines operated
screwdriver bits and connecting parts
- ISO 691 /DIN 475-2
Socket openings - Tolerances for general use
- ISO 2936 / DIN 911
Hexagon socket screw keys - Tolerances for male hexagon

The logo consists of three horizontal white bars of varying lengths, with the text 'Atlas Copco' in a white serif font centered between the middle and bottom bars.

Atlas Copco

Atlas Copco AB

(publ) SE-105 23 Stockholm, Sweden

Phone: +46 8 743 80 00

Reg. no.: 556014-2720

atlas-copco.com